



buffet | tabletop | bar



SINCE 1933

2026
NOVELTIES
SPRING



DISCOVER
OVER **300 NEW**
PRODUCTS!

NEW PRODUCTS

Spring 2026

Nie war unser Frühling vielfältiger

Über 300 Produkte feiern Premiere – zahlreiche Ergänzungen schließen Lücken in bestehenden Linien, neue Farbvarianten schärfen die visuelle Aussage, und ganz neue Serien eröffnen zusätzliche Spielräume in Design und Funktion. Über alle Produktwelten hinweg entsteht ein in sich stimmiges, aufeinander abgestimmtes Sortiment: Größen und Proportionen greifen ineinander, Varianten lassen sich nahtlos kombinieren – mit durchdachter Systemlogik, hoher Alltagstauglichkeit und klarer, durchgängiger Gestaltung.

Never has our spring been more diverse

Over 300 products are making their debut – numerous additions close gaps in existing lines, new colour variants sharpen the visual statement, and entirely new series open up additional possibilities in design and function. Across all product worlds, a coherent, well-balanced range is emerging: sizes and proportions interlock, variants can be combined seamlessly – with a thoughtful system logic, high everyday practicality, and a clear, consistent design language.

p. 16



p. 44

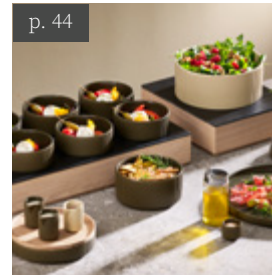

p. 56



p. 84



p. 96



p. 100



VALO



GN 1/1 Holzbox „VALO“

GN 1/1 woodbox
GN 1/1 caja madera
GN 1/1 base bois



	cm	↑ cm	GN	Farbe / colour	€
14000	53 x 32,5	4,5	1/1	oiled	76,00
14001	53 x 32,5	8,5	1/1	oiled	92,00
14002	53 x 32,5	16,5	1/1	oiled	136,00
14100 <small>NEW</small>	53 x 32,5	4,5	1/1	lacquered	84,00
14101 <small>NEW</small>	53 x 32,5	8,5	1/1	lacquered	100,00
14102 <small>NEW</small>	53 x 32,5	16,5	1/1	lacquered	148,00





GN 1/2 Holzbox „VALO“

GN 1/2 woodbox
GN 1/2 caja madera
GN 1/2 base bois



	cm	↑ cm	GN	Farbe / colour	€
14003	32,5 x 26,5	4,5	1/2	(oiled)	54,00
14004	32,5 x 26,5	8,5	1/2	(oiled)	66,00
14005	32,5 x 26,5	16,5	1/2	(oiled)	92,00
14103 NEW	32,5 x 26,5	4,5	1/2	(lacquered)	59,00
14104 NEW	32,5 x 26,5	8,5	1/2	(lacquered)	72,00
14105 NEW	32,5 x 26,5	16,5	1/2	(lacquered)	100,00

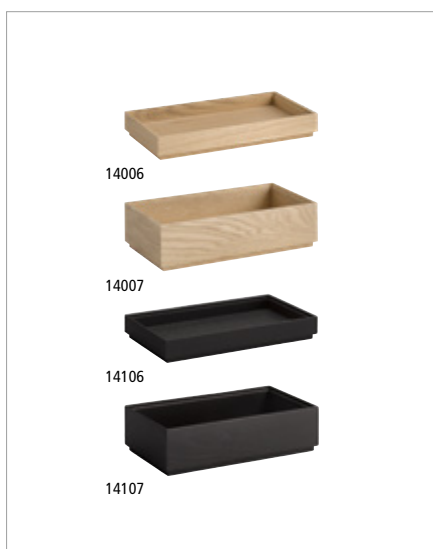

GN 1/3 Holzbox „VALO“

GN 1/3 woodbox
GN 1/3 caja madera
GN 1/3 base bois



	cm	↑ cm	GN	Farbe / colour	€
14006	32,5 x 17,6	4,5	1/3	(oiled)	46,00
14007	32,5 x 17,6	8,5	1/3	(oiled)	54,00
14106 NEW	32,5 x 17,6	4,5	1/3	(lacquered)	50,00
14107 NEW	32,5 x 17,6	8,5	1/3	(lacquered)	59,00



GN 1/6 Holzbox „VALO“

GN 1/6 woodbox
GN 1/6 caja madera
GN 1/6 base bois



	cm	↑ cm	GN	Farbe / colour	€
14027	17,6 x 16,2	8,5	1/6	(oiled)	46,00
14127	17,6 x 16,2	8,5	1/6	(lacquered)	50,00



GN 2/4 Holzbox „VALO“

GN 2/4 woodbox
GN 2/4 caja madera
GN 2/4 base bois

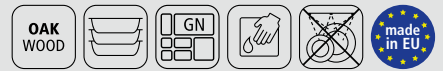

	cm	↑ cm	GN	Farbe / colour	€
14008	53 x 16,2	4,5	2/4	(oiled)	60,00
14009	53 x 16,2	8,5	2/4	(oiled)	71,00
14108 <small>NEW</small>	53 x 16,2	4,5	2/4	(lacquered)	65,00
14109 <small>NEW</small>	53 x 16,2	8,5	2/4	(lacquered)	78,00



GN Naturschieferplatte

GN natural slate tray
GN bandeja de pizarra natural
GN plat ardoise naturelle



Schieferplatten mit möbelschonenden Füßchen – ideal als Auflage für GN Holzboxen

slate trays with furniture-friendly feet – ideal as an overlay for GN wooden boxes

bandejas pizarra con pies protege-muebles – ideales como soporte para cajas de madera GN

plateaux en ardoise avec pieds protégé-meubles – idéals pour les caisses en bois GN

	cm	* mm	GN	€
01001	53,0 x 32,5	6-9	1/1	16,40
01003	32,5 x 26,5	6-9	1/2	9,20
01004	32,5 x 17,6	6-9	1/3	5,60
01002	53,0 x 16,2	6-9	2/4	6,80



Einsatz für GN 1/1 Holzbox „VALO“

insert for GN 1/1 woodbox
separador para GN 1/1 caja madera
insert pour GN 1/1 base bois



Einsatz ergibt 15 Fächer (9,5 x 9,5 cm)

insert creates 15 compartments (9,5 x 9,5 cm)

separador ofrece 15 compartimentos (9,5 x 9,5 cm)

insert donnant 15 compartiments (9,5 x 9,5 cm)

	cm	↑ cm	fits to	fits to	€
14021	50,5 x 30	6	GN 1/1	14001, 14101	36,00





Einsatz für GN 1/2 Holzbox, 2er Set „VALO“

insert for GN 1/2 woodbox, set of 2
 separador para GN 1/2 caja madera, set de 2
 insert pour GN 1/2 base bois, set de 2



Einsatz ergibt 3 Fächer, ideal für Besteck

insert creates 3 compartments, ideal for cutlery
 separador ofrece 3 compartimentos, ideal para cubiertos
 insert donnant 3 compartiments, idéal pour les couverts

	cm	↑ cm	fits to	pcs.	€/ set
14022	24 x 10,5	6	GN 1/2, 14004, 14104	2	21,00



Einsatz für GN Holzbox „VALO“

insert for GN woodbox
 inserto para GN caja madera
 insert pour GN base bois



passende Einsätze für GN Holzboxen, ideal zum Befüllen mit Crushed Eis

suitable insert for GN wooden boxes, ideal for filling with crushed ice
 inserto para cajas de madera GN, ideal para rellenar con hielo picado
 insert supérieur pour caisses en bois GN, idéal pour le remplissage avec de la glace pilée

	cm	↑ cm	GN	fits to	€
14041	51,5 x 31	6	1/1	14001, 14101	35,00
14036	51,5 x 31	14	1/1	14002, 14102	38,00
14042	31,0 x 25	6	1/2	14004, 14104	25,00
14037	31,0 x 25	14	1/2	14005, 14105	28,00
14043 <small>NEW</small>	51,5 x 15	6	2/4	14009, 14109	25,00

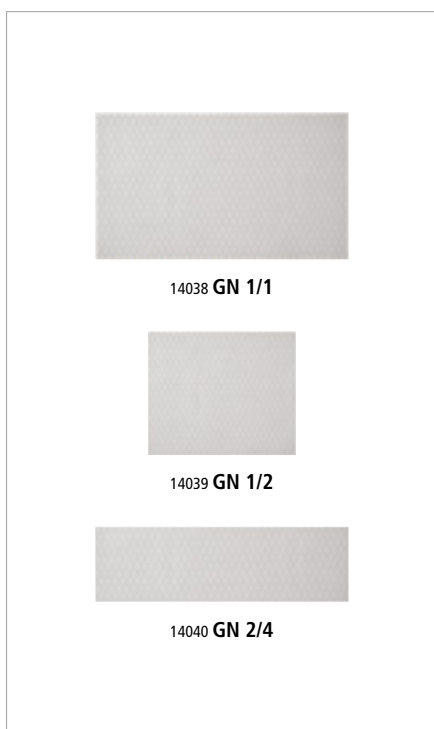

Antirutschmatte für GN Holzbox „VALO“

anti-slip mat for GN woodbox
 alfombrilla antideslizante para GN caja madera
 tapis antidérapant pour GN base bois



zur Einlage in GN Holzboxen, schützt das Holz vor fettenden oder ölhaltigen Lebensmitteln

for insertion into GN wooden boxes, protects the wood from greasy or oily foods
 para colocar en cajas de madera GN, protege la madera de alimentos grasos o aceitosos
 a placer dans des caisses en bois GN, protège le bois des aliments gras ou huileux

	cm	fits to	€
14038	50,4 x 30,0	GN 1/1	10,00
14039	30,0 x 24,1	GN 1/2	8,00
14040	50,4 x 13,8	GN 2/4	8,00

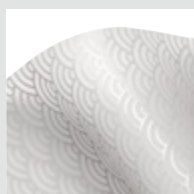

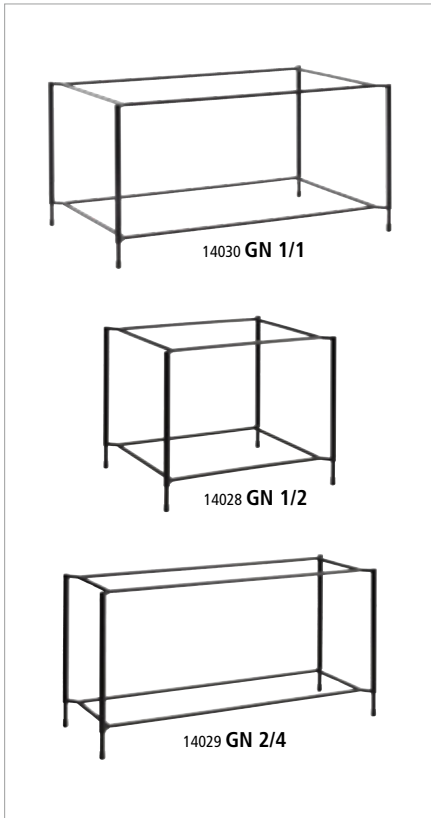

GN Buffetständer „VALO“

GN buffet stand
GN soporte para buffet
GN présentoir buffet



multifunktionaler, stapelbarer Buffetständer aus pulverbeschichtetem Metall

multifunctional, stackable buffet stand made of powder-coated metal
soporte multifuncional apilable para buffet fabricado en metal con recubrimiento en polvo
support de buffet multifonctionnel empilable en métal revêtu par poudre

	cm	↑ cm	GN	€
14030	57,0 x 37	28,5	1/1	160,00
14028 <small>NEW</small>	36,5 x 31	28,5	1/2	140,00
14029 <small>NEW</small>	57,0 x 21	28,5	2/4	140,00

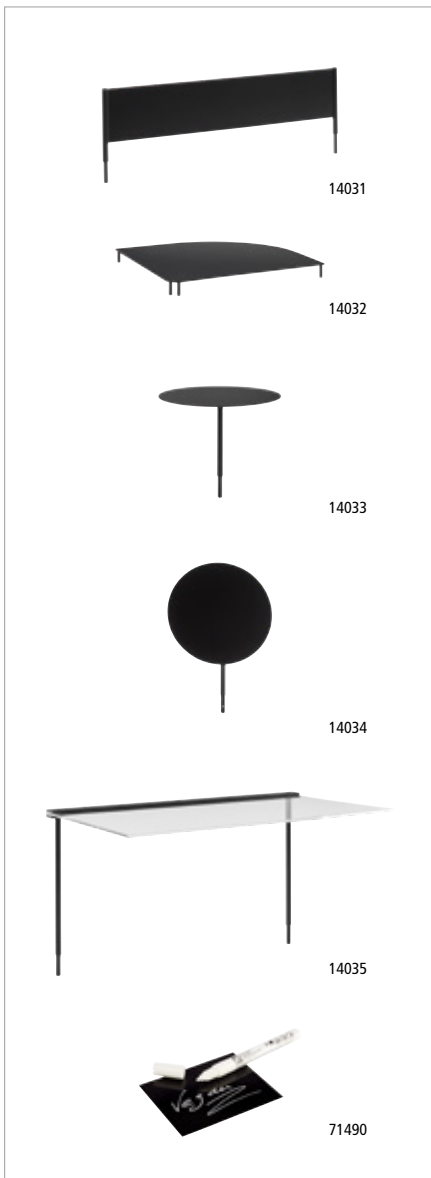

Buffetständer Zubehör „VALO“

buffet stand accessories
accesorios para soportes de buffet
accessoires pour présentoirs de buffet



multifunktionales Zubehör aus pulverbeschichtetem Metall:

• Stecktafel (beschriftbar) • Eckverbindung • Podest • Schild (beschriftbar) • Hygieneschutz

multifunctional accessories made of powder-coated metal:

• pegboard • corner connection • platform • shield • hygienic protection

accesorios multifuncionales de metal con recubrimiento en polvo:

• tablero de anuncios • conexión de esquina • plataforma • cartel • protección higiénica

accessoires multifonctionnels en métal thermolaqué:

• panneau d'affichage • raccord d'angle • plateforme • panneau • protection hygiénique

	cm	↑ cm	fits to	€
14031	57,0 x 1,0	19,5	14029, 14030	38,00
14032	39,0 x 39,0	3,0	14028, 14030	56,00
14033	∅ 25	20,5	14028, 14029, 14030	30,00
14034	∅ 25	33,0	14028, 14029, 14030	30,00
14035	60,5 x 36,5	33,5	14029, 14030	130,00

Kreidemarker, 2er Set

chalk marker, set of 2
rotulador de tiza, set de 2
marqueur a la craie liquide, set de 2



	∅ cm	↑ cm	Farbe / colour	pcs.	€ / set
71490	1	13		2	6,50





Etagère, 3-stufig „VALO“

3-tier tray
bandeja 3 alturas
étagère carré 3 hauteurs



untere Ebene GN 1/1, mittlere Ebene 53 x 26,5 cm, obere Ebene GN 2/4

lower level GN 1/1, middle level 53 x 26,5 cm, upper level GN 2/4

nivel inferior GN 1/1, nivel medio 53 x 26,5 cm, nivel superior GN 2/4

niveau inférieur GN 1/1, niveau intermédiaire 53 x 26,5 cm, niveau supérieur GN 2/4

	cm	↑ cm	fits to	€
14012	55,5 x 32,5	64	GN 1/1, 2/4	248,00



Etagère, 2-stufig „VALO“

2-tier tray
bandeja 2 alturas
étagère carré 2 hauteurs



untere Ebene 53 x 26,5 cm, obere Ebene GN 2/4

lower level 53 x 26,5 cm, upper level GN 2/4

nivel inferior 53 x 26,5 cm, nivel superior GN 2/4

niveau inférieur 53 x 26,5 cm, niveau supérieur GN 2/4

	cm	↑ cm	fits to	€
14011	55,5 x 26,5	44,5	GN 2/4	190,00



Etagère, 2-stufig „VALO“

2-tier tray
bandeja 2 alturas
étagère carré 2 hauteurs



untere Ebene GN 1/2, obere Ebene GN 1/3

lower level GN 1/2, upper level GN 1/3

nivel inferior GN 1/2, nivel superior GN 1/3

niveau inférieur GN 1/2, niveau supérieur GN 1/3

	cm	↑ cm	fits to	€
14010	35,0 x 26,5	44,5	GN 1/2, 1/3	164,00



Etagère, 3-stufig „VALO“

3-tier tray
bandeja 3 alturas
étagère carré 3 hauteurs



untere Ebene Ø 30 cm, mittlere Ebene Ø 25 cm, obere Ebene Ø 17 cm

lower level Ø 30 cm, middle level Ø 25 cm, upper level Ø 17 cm

nivel inferior Ø 30 cm, nivel medio Ø 25 cm, nivel superior Ø 17 cm

niveau inférieur Ø 30 cm, niveau intermédiaire Ø 25 cm, niveau supérieur Ø 17 cm

	Ø cm	↑ cm	€
14014	30	42	87,00



Etagère, 2-stufig „VALO“

2-tier tray
bandeja 2 alturas
étagère carré 2 hauteurs



untere Ebene Ø 30 cm, obere Ebene Ø 25 cm

lower level Ø 30 cm, upper level Ø 25 cm

nivel inferior Ø 30 cm, nivel superior Ø 25 cm

niveau inférieur Ø 30 cm, niveau supérieur Ø 25 cm

	Ø cm	↑ cm	€
14013	30	28	68,00

NEW

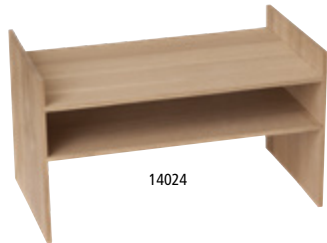

14024



Buffetgestell für GN Holzboxen „VALO“

buffet stand for GN wooden boxes
 soporte para buffet para cajas de madera GN
 présentoir buffet pour caisses en bois GN
multifunktionales Gestell, kombinierbar mit GN Holzboxen
 multifunctional rack, can be combined with GN wooden boxes
 estructura multifuncional, combinable con cajas de madera GN
 support multifonctionnel, combinable avec des caisses en bois GN

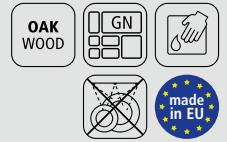

	cm	↑ cm	fits to	€
14024	55,5 x 32	32	GN wooden boxes	174,00

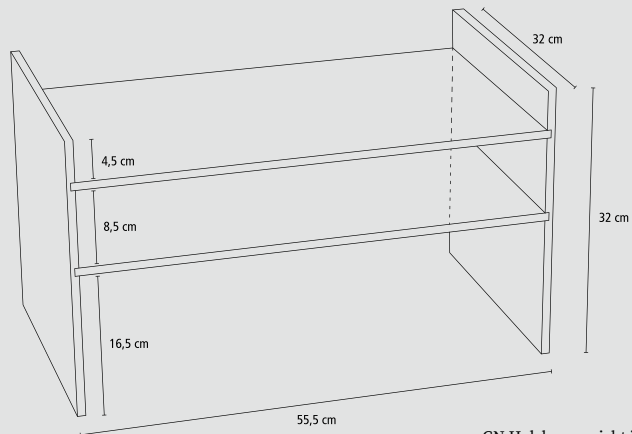

GN Holzboxen nicht im Lieferumfang enthalten
 GN wooden boxes not included in delivery



01002
1x GN 2/4



14009
1x GN 2/4



14008
1x GN 2/4



14004
2x GN 1/2



14002
1x GN 1/1



Etagère, 2-stufig „VALO“

2-tier tray
bandeja 2 alturas
étagère carré 2 hauteurs

untere Ebene 52 x 26,5 cm, obere Ebene 52 x 16 cm

lower level 52 x 26,5 cm, upper level 52 x 16 cm

nivel inferior 52 x 26,5 cm, nivel superior 52 x 16 cm

niveau inférieur 52 x 26,5 cm, niveau supérieur 52 x 16 cm



	cm	↑ cm	€
14020	54 x 26,5	26,5	189,00



**angewinkelte Innenbox
für ideale Präsentation**
angled inner box
for ideal presentation



GN 1/1 Brotschneidebrett „VALO“

GN 1/1 cutting board

GN 1/1 tabla de cortar

GN 1/1 planche à découper

massives Brotschneidebrett mit Antirutschfüßchen für sicheren Halt

solid cutting board with non-slip feet for a secure hold

tabla de cortar pan maciza con pies antideslizantes para una sujeción segura

planche à découper massive avec pieds antidérapants pour une bonne stabilité



	cm	↑ cm	GN	€
00764	53 x 32,5	3,5	1/1	100,00



Brotmesser

bread knife

cuchillo para pan

couteau à pain

Brotmesser aus rostfreiem Edelstahl, dreifach genietet, mit Griff aus Buchenholz

bread knife made of stainless steel, triple riveted, with beech wood handle

cuchillo para pan de acero inoxidable, triple remachado, con mango de madera de haya

couteau à pain en acier inox, triplement riveté, avec manche en bois de hêtre



	→ cm	€
88990	34	16,00

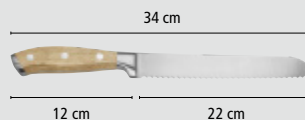

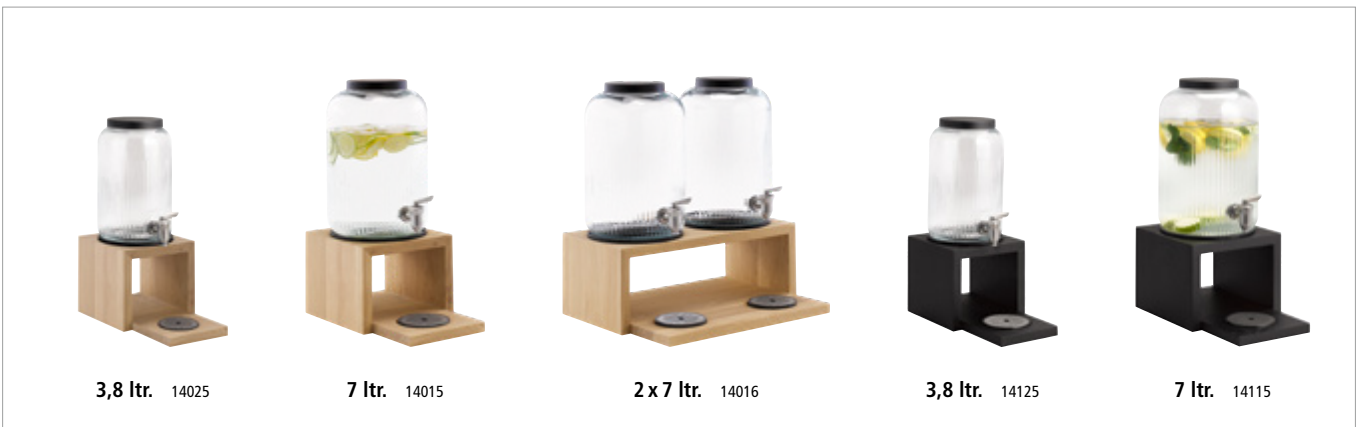

Getränkespender „VALO“

beverage dispenser
dispensador de bebidas
distributeur de boissons

Podest wasserfest lackiert, Zapfhahn aus Edelstahl,
Untersetzer aus Melamin, Bodenplatte (Gläserntablett) herausnehmbar

platform waterproof lacquered, stainless steel tap,
melamine coaster, removeable base plate

podio con barniz impermeable, grifo de acero inoxidable,
posavasos de melamina, placa base extraíble

podium verni imperméable, robinet en acier inox,
dessous de verre en mélamine, plaque de fond amovible



	cm	↑ cm	ltr.	Farbe / colour	€
14025	18,0 x 18,0	41,0	3,8		200,00
14015	21,0 x 21,0	46,5	7,0		240,00
14016	43,5 x 21,0	46,5	2x 7,0		390,00
14125 NEW	18,0 x 18,0	41,0	3,8		220,00
14115 NEW	21,0 x 21,0	46,5	7,0		260,00



Eiswasserröhre

ice cube cooling tube
tubo enfriador para cubitos
tube pour glaçons



	Ø cm	↑ cm	fits to	€
10849	11	23	14015, 14016, 14025, 14115, 14125	9,40



Glaskaraffe „LINES“

glass carafe
jarra de vidrio
carafe en verre



ideal für Cerealien, Säfte oder Milch, Deckel aus Kork

ideal for cereals, juices or milk, cork lid

ideal para cereales, zumos o leche, tapa de corcho

idéal pour les céréales, les jus de fruits ou le lait, couvercle en liège

	Ø cm	↑ cm	ltr.	fits to	€
10725	9	19,5	0,5	14023, 14070, 14075, 14077, 14123, 14170	15,00
10726	9	27,5	1,0	14023, 14070, 14075, 14077, 14123, 14170	21,00
10727	9	35,0	1,5	14023, 14070, 14075, 14077, 14123, 14170	22,00



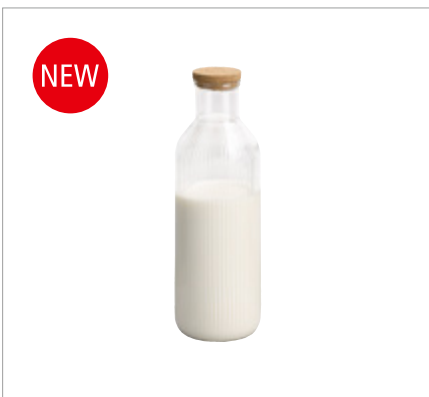

Glaskaraffe „LINES“

glass carafe
jarra de vidrio
carafe en verre

GLASS CORK

ideal für Milch oder Säfte, Deckel aus Kork
ideal for milk or juices, cork lid
ideal para leche o zumos, tapa de corcho
idéal pour le lait ou les jus de fruits, couvercle en liège

	Ø cm	↑ cm	ltr.	fits to	€
10735	9	27	1	10736, 14023, 14123	21,00



Labelclips, 4er Set

label clips, set of 4
etiqueta clip, set de 4
étiquette clip, set de 4

STAINLESS STEEL

vier verschiedene Beschriftungen (milk, oat, almond, soy) – passend für Glaskaraffe Nr. 10735
four different labels (milk, oat, almond, soy) – suitable for glass carafe no. 10735
cuatro etiquetas diferentes (milk, oat, almond, soy) – aptas para jarra de cristal no. 10735
quatre inscriptions différentes (milk, oat, almond, soy) – pour la carafe en verre no. 10735

	Ø cm	↑ cm	fits to	pcs.	€ / set
10736	4,5	2,5	10735	4	8,80

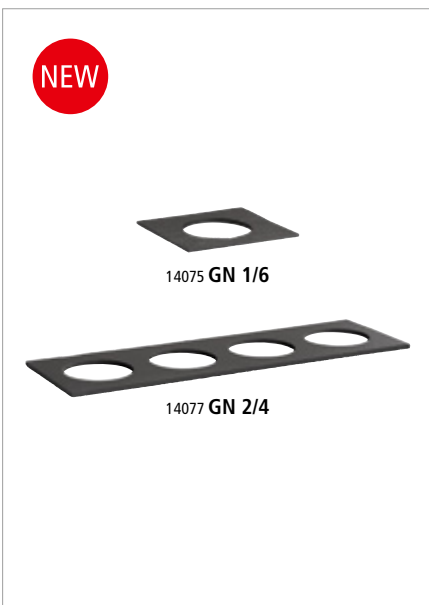

GN Naturschieferplatte

GN natural slate tray
GN bandeja de pizarra natural
GN plat ardoise naturelle

SLATE GN

Schieferplatte mit Ausschnitt (Ø 10,5 cm) – passend für Glaskaraffe Nr. 10735
slate plate with cut-out (Ø 10,5 cm) – suitable for glass carafe no. 10735
placa de pizarra con recorte (Ø 10,5 cm) – apta para jarra de cristal no. 10735
plaque d'ardoise avec découpe (Ø 10,5 cm) – pour la carafe en verre no. 10735

	cm	✂ mm	GN	fits to	€
14075	17,6 x 16,2	6-9	1/6	14027, 14127	4,20
14077	53,0 x 16,2	6-9	2/4	14009, 14109	11,00



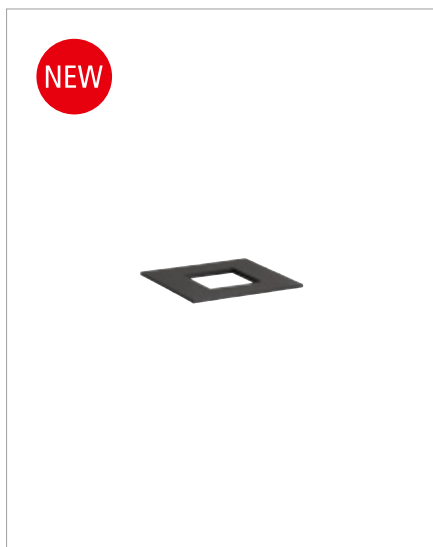

GN 1/6 Naturschieferplatte

GN 1/6 natural slate tray
GN 1/6 bandeja de pizarra natural
GN 1/6 plat ardoise naturelle



Schieferplatte mit Ausschnitt (8,3 x 8,3 cm) – passend für handelsübliche Milch- oder Saftkartons

slate plate with cut-out (8,3 x 8,3 cm) – suitable for standard milk or juice cartons

placa de pizarra con recorte (8,3 x 8,3 cm) – para envases estándar de leche o zumo

plaque en ardoise avec découpe (8,3 x 8,3 cm) – pour briques de lait ou de jus standard

	cm	✂ mm	GN	fits to	€
14076	17,6 x 16,2	6-9	1/6	14027, 14127	4,20



GN 1/6 Kühlbox, 4-tlg. Set „VALO“

GN 1/6 cool box, 4-piece set
GN 1/6 nevera portátil, set de 4 piezas
GN 1/6 glacière, set de 4 pièces



4-teiliges Set, bestehend aus:

- 1 GN 1/6 Holzbox, 1 Einsatz aus EPP, 1 Kühlakku aus PE, 1 GN 1/6 Naturschieferplatte mit Ausschnitt (Ø 10,5 cm)

4 pcs., consisting of:

- 1 GN 1/6 woodbox, 1 insert made of EPP, 1 cooling pack made of PE, 1 GN 1/6 natural slate plate with cut-out (Ø 10,5 cm)

set de 4, compuesto por:

- 1 caja de madera GN 1/6, 1 inserto de EPP, 1 acumulador de frío de PE, 1 placa de pizarra natural GN 1/6 con recorte (Ø 10,5 cm)

set de 4, composé de:

- 1 boîte en bois GN 1/6, 1 insert en EPP, 1 accumulateur de froid en PE, 1 plaque en ardoise naturelle GN 1/6 avec découpe (Ø 10,5 cm)

	cm	↑ cm	GN	Farbe / colour	€
14070	17,6 x 16,2	9	1/6	(oiled)	64,00
14170	17,6 x 16,2	9	1/6	(lacquered)	69,00



Kühlakku

cooler
acumulador de frío
accumulateur de froid



	cm	↑ cm	fits to	€
10662 NEW	Ø 10,5	2,0	14079	3,40
10791	25 x 19	2,5	14078	8,40



Einsatz „VALO“

insert
inserto
insert



	cm	↑ cm	fits to	€
14079	14 x 12,5	5	GN 1/6, GN 2/4	12,00
14078	30 x 24,0	4	GN 1/2, GN 1/1	13,00



NEW

Frischhaltehaube „VALO“

cover
campana
cloche



stilvoll abgedeckt und geschützt – passend für Servier- und Tortenplatten Nr. 14095 & 14096
 stylishly covered and protected – compatible with cake stands no. 14095 & 14096
 elegante y protegida – compatible con porta pasteles no. 14095 & 14096
 couverts et protégés avec style – compatible avec présentoir à gâteaux no. 14095 & 14096

	Ø cm	↑ cm	fits to	€
14097	30	16	14095, 14096, 19044, 19084	35,00



NEW

Teller „THE GRID“

plate
plato
assiette



	Ø cm	↑ cm	fits to	Farbe / colour	€
19044	32,0	2,5	14097	sand	36,00
19084	32,0	2,5	14097	mud	36,00

19044

19084



NEW



Servier- und Tortenplatte „VALO“

cake stand
porta pasteles
présentoir à gâteaux

für eine stilvolle Präsentation von Kuchen und Gebäck, Ø Standfuß: 12 cm

for a stylish presentation of cakes and pastries, Ø base: 12 cm

presentación elegante de pasteles y repostería, Ø base: 12 cm

présentation élégante de gâteaux et pâtisseries, Ø socle: 12 cm



	Ø cm	↑ cm	fits to	Farbe / colour	€
14095	32	8,5	14097	(oiled)	89,00



NEW



Servier- und Tortenplatte „VALO“

cake stand
porta pasteles
présentoir à gâteaux

für eine stilvolle Präsentation von Kuchen und Gebäck, Ø Standfuß: 15 cm

for a stylish presentation of cakes and pastries, Ø base: 15 cm

presentación elegante de pasteles y repostería, Ø base: 15 cm

présentation élégante de gâteaux et pâtisseries, Ø socle: 15 cm



	Ø cm	↑ cm	fits to	Farbe / colour	€
14096	32	17	14097	(oiled)	99,00





Glaskaraffe „LINES“

glass carafe
jarra de vidrio
carafe en verre

GLASS CORK

ideal für Cerealien, Säfte oder Milch, Deckel aus Kork

ideal for cereals, juices or milk, cork lid

ideal para cereales, zumos o leche, tapa de corcho

idéal pour les céréales, les jus de fruits ou le lait, couvercle en liège

	∅ cm	↑ cm	ltr.	fits to	€
10725	9	19,5	0,5	14023, 14123	15,00
10726	9	27,5	1,0	14023, 14123	21,00
10727	9	35,0	1,5	14023, 14123	22,00



3er-Podest für Glaskaraffen „VALO“

podest for 3 glass carafes
pedestal para 3 jarras de vidrio
podium pour 3 carafes en verre

OAK WOOD

ideal für eine stets geordnete Präsentation am Buffet

ideal for a constantly organised presentation at the buffet

ideal para una presentación constantemente organizada en el buffet

idéal pour une présentation toujours ordonnée au buffet

	cm	↑ cm	fits to	Farbe / colour	€
14023	41 x 16	12	10725, 10726, 10727, 10735	(oiled)	49,00
14123	41 x 16	12	10725, 10726, 10727, 10735	(lacquered)	54,00



0,75 ltr.

Glaskaraffe „LINES“

glass carafe
jarra de vidrio
carafe en verre

GLASS

CORK

ideal für Cerealien, Säfte oder Milch, Deckel aus Kork

ideal for cereals, juices or milk, cork lid

ideal para cereales, zumos o leche, tapa de corcho

idéal pour les céréales, les jus de fruits ou le lait, couvercle en liège

	Ø cm	↑ cm	ltr.	fits to	€
10738	8	28	0,75	14019	20,00

**1er-Podest für Glaskaraffen „VALO“**

podest for 1 glass carafe
pedestal para 1 jarra de vidrio
podium pour 1 carafe en verre

OAK
WOOD**ideal für eine stets geordnete Präsentation am Buffet**

ideal for a constantly organised presentation at the buffet

ideal para una presentación constantemente organizada en el buffet

idéal pour une présentation toujours ordonnée au buffet

	cm	↑ cm	fits to	€
14019	15 x 15	12	10738	15,00

**Serviettenhalter „VALO“**

napkin holder
servilletero
porte-serviettes

OAK
WOOD

METAL

**für ca. 100 Servietten mit 1/4 Falz, inklusive Beschwerer**

for approx. 100 napkins with 1/4 fold, including weight

para aprox. 100 servilletas con 1/4 de pliegue, con barra de contrapeso

pour env. 100 serviettes pliées en 1/4, avec barre de contrepois

	cm	↑ cm	€
14092	19 x 19	16	59,00

**Table Caddy „VALO“**

table caddy
caddy de mesa
caddy de table

OAK
WOOD

METAL

**2 Fächer: 6 x 6 cm / 1 Fach: 6 x 13 cm**

2 compartments: 6 x 6 cm / 1 compartment: 6 x 13 cm

2 compart. 6 x 6 cm, 1 compart. 6 x 13 cm

2 compart. 6 x 6 cm, 1 compart. 6 x 13 cm

	cm	↑ cm	€
14090	15 x 15	28	72,00

**Table Caddy „VALO“**

table caddy
caddy de mesa
caddy de table

OAK
WOOD**2 Fächer: 6 x 6 cm / 1 Fach: 6 x 13 cm**

2 compartments: 6 x 6 cm / 1 compartment: 6 x 13 cm

2 compart. 6 x 6 cm, 1 compart. 6 x 13 cm

2 compart. 6 x 6 cm, 1 compart. 6 x 13 cm

	cm	↑ cm	€
14091	15 x 15	31	84,00



14050

14150

Induktionsstation, 2-tlg. Set „VALO“

induction station, 2-piece set
 estación de inducción, set de 2 piezas
 station à induction, set de 2 pièces



2-teiliges Set, bestehend aus:

- 1 Induktionskochplatte inklusive Kabelfernbedienung, Leistung in Stufen regelbar
- 1 Rahmen (wasserfest lackiert)

2 pcs., consisting of:

- 1 induction hotplate including cable remote control, power adjustable in steps
- 1 frame (waterproof lacquered)

set de 2, compuesto por:

- 1 placa de inducción con mando a distancia con cable, potencia regulable por niveles
- 1 marco (barnizado resistente al agua)

set de 2, composé de :

- 1 plaque à induction avec télécommande filaire, puissance réglable par paliers
- 1 cadre (vernis imperméable)

	cm	↑ cm		Farbe / colour	€
14050	38,5 x 38,5	10	2000 W		300,00
14150 NEW	38,5 x 38,5	10	2000 W		310,00



Kabelfernbedienung
 cable remote control



Serviertablett „VALO“

tray
bandeja
plateau



Innenmaß 56 x 36 cm, kombinierbar mit dem Tablettständer Nr. 14061

inside dimension 56 x 36 cm, can be combined with tray stand no. 14061

dimension interior 56 x 36 cm, combinable con el soporte para bandejas no. 14061

dimension intérieure 56 x 36 cm, combinable avec le support pour plateau no. 14061

	cm	↑ cm	fits to	€
14060	60 x 40	3	14061	82,00

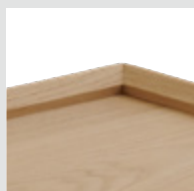

Tablettständer „VALO“

tray stand
soporte para bandeja
support de plateau



zusammenklappbar, kombinierbar mit dem Serviertablett Nr. 14060, Tragfähigkeit: 50 kg

collapsible, can be combined with serving tray no. 14060, load capacity: 50 kg

plegable, combinable con la bandeja de servicio no. 14060, capacidad de carga: 50 kg

pliable, combinable avec le plateau de service no. 14060, capacité de charge: 50 kg

	cm	↑ cm	fits to	€
14061	56 x 35,5	75	14060	130,00

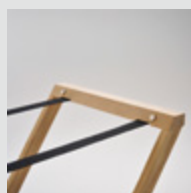

mit Magnetbefestigung
with magnetic attachment



VALUMO



VALUMO – Ihr Buffet, perfekt beleuchtet. Kabellos. Flexibel. Stilvoll.

VALUMO – Your buffet, perfectly illuminated.
Wireless. Flexible. Stylish.

Das Buffet-Beleuchtungssystem **VALUMO** überzeugt durch seine Kombination aus modernem Design und praktischer Funktionalität. Es besteht aus den Leuchtköpfen Nr. 17090 & 17096 und fünf flexiblen Halterungen. Dank der Magnetkugelfestigung lässt sich der Leuchtkopf nahezu 360 Grad drehen, um das Licht präzise auszurichten.

Die Steuerung erfolgt ganz bequem über eine Fernbedienung oder direkt über den Touch-Button am Gehäuse. Mit Kaltweiß, Warmweiß und RGB-Farben bietet **VALUMO** vielfältige Beleuchtungsoptionen für jede Stimmung und jeden Anlass.

Der Leuchtkopf wird über die mitgelieferte Ladeplatte oder die optional erhältlichen Mehrfach-Ladeplatten aufgeladen – eine Lösung, die kabellosen Komfort und maximale Flexibilität garantiert.

VALUMO ist die ideale Ergänzung für jedes Buffet und eignet sich perfekt für unser Buffetsystem **VALO**. Es lässt sich nahtlos integrieren und flexibel kombinieren, um individuellen Anforderungen gerecht zu werden.

The **VALUMO** buffet lighting system impresses with its combination of modern design and practical functionality. It consists of the light heads no. 17090 & 17096 and five flexible brackets. Thanks to the magnetic ball attachment, the light head can be rotated almost 360 degrees to precisely align the light.

It can be conveniently controlled via a remote control or directly via the touch button on the housing. With cool white, warm white and RGB colours, **VALUMO** offers a wide range of lighting options for every mood and occasion.

The light head is charged via the supplied charging plate or the optionally available multiple charging plates - a solution that guarantees wireless convenience and maximum flexibility.

VALUMO is the ideal addition to any buffet and the perfect complement to our **VALO** buffet system. It integrates seamlessly and can be flexibly combined to meet individual requirements.

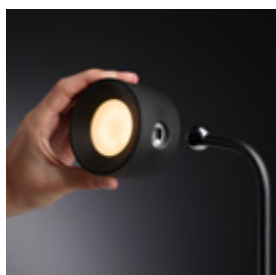

Magnetkugelfestigung
magnetic ball mounting



nahezu 360 Grad drehbar
almost 360 degrees rotatable

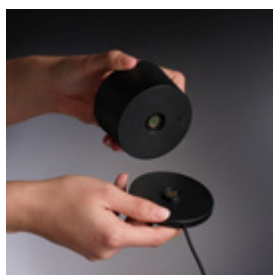

Ladestation
charging station



Leuchtkopf light head cabezal luminoso tête lumineuse



inklusive Ladestation, USB Ladekabel (ohne Netzteil), Fernbedienung inklusive Batterie
charging station included, USB charging cable (without mains adapter), remote control including battery
con estación de carga, cable de carga USB (sin adaptador de red), mando a distancia con pila incluida
avec station de charge, câble de charge USB (sans bloc d'alimentation), télécommande incluse pile

	∅ cm	↑ cm	€
17096	10,0	4,5	34,00



Leuchtkopf light head cabezal luminoso tête lumineuse



inklusive Ladestation, USB Ladekabel (ohne Netzteil), Fernbedienung inklusive Batterie
charging station included, USB charging cable (without mains adapter), remote control including battery
con estación de carga, cable de carga USB (sin adaptador de red), mando a distancia con pila incluida
avec station de charge, câble de charge USB (sans bloc d'alimentation), télécommande incluse pile

	∅ cm	↑ cm	€
17090	7,5	5,0	30,00



2er Standfuß inklusive Stab „VALUMO“

2-piece stand including rod
soporte de 2 con varilla incluida
pied de 2 avec tige incluse

bestehend aus 3 Elementen: Standfuß mit Stab, Erweiterungsstab, Magnetkugeln

consisting of 3 elements: stand with rod, extension rod, magnetic spheres
compuesto por 3 elementos: soporte con varilla, varilla de prolongación, esferas magnéticas
composé de 3 éléments : pied avec tige, tige de rallonge, boules magnétiques

METAL

	∅ cm	↑ cm	€
17095	17	31 - 51	24,00



1er Standfuß inklusive Stab „VALUMO“

stand including rod
soporte con varilla incluida
pied de support, tige incluse

bestehend aus 3 Elementen: Standfuß mit Stab, Erweiterungsstab, Magnetkugel

consisting of 3 elements: stand with rod, extension rod, magnetic sphere
compuesto por 3 elementos: soporte con varilla, varilla de prolongación, esfera magnética
composé de 3 éléments : pied avec tige, tige de rallonge, boule magnétique

METAL

	∅ cm	↑ cm	€
17092	14	31 - 51	20,00

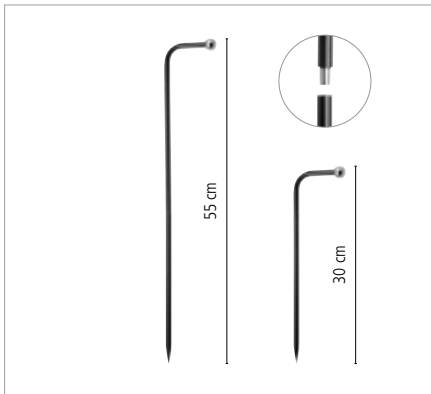

Stab zum Stecken „VALUMO“

stick for insertion
varilla de inserción
tige à enfoncer

bestehend aus 3 Elementen: Spitze (24 cm), Erweiterungsstab, Magnetkugel

consisting of 3 elements: tip (24 cm), extension rod, magnetic sphere
compuesto por 3 elementos: punta (24 cm), varilla de prolongación, esfera magnética
composé de 3 éléments : pointe (24 cm), tige de rallonge, boule magnétique

METAL

	∅ cm	↑ cm	fits to	€
17093	0,9	30 - 55	14028, 14029, 14030	9,00

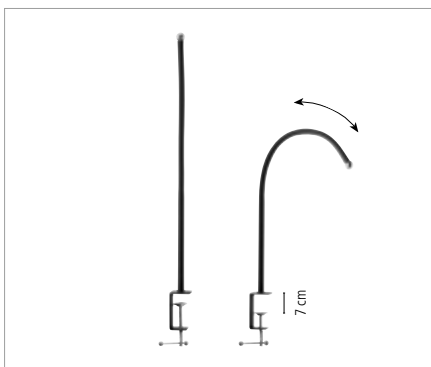

Schraubklammer mit flexiblem Arm „VALUMO“

screw clamp with flexible arm
abrazadera de tornillo con brazo flexible
pince à visser avec bras flexible

zum Befestigen an Buffetelementen oder Tischplatten, mit flexiblem Arm

for attachment to buffet elements or table tops, with flexible arm
para fijar a elementos de buffet o tableros de mesa, con brazo flexible
à fixer sur des éléments de buffet ou des plateaux de table, avec bras flexible

METAL

	cm	↑ cm	€
17094	4,5 x 4	64	19,00

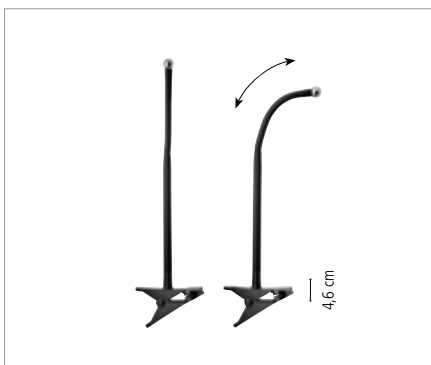

Klammer mit flexiblem Arm „VALUMO“

clamp with flexible arm
pinza con brazo flexible
agrafe avec bras flexible

zum einfachen Befestigen an Buffetelementen oder Tischplatten, mit flexiblem Arm

for easy attachment to buffet elements or table tops, with flexible arm
para fijar fácilmente a elementos de buffet o tableros de mesa, con brazo flexible
pour une fixation facile sur des éléments de buffet ou des plateaux de table, avec bras flexible

ABS

METAL

	cm	↑ cm	€
17091	11 x 7,5	40	16,00





When buffet meets table –
a modular link





THE GRID überträgt das modulare Prinzip von VALO auf eine neue Ebene: Das System schafft fließende Übergänge zwischen Buffet und Tisch – für ein durchgängiges Konzept, das Effizienz, Design und Atmosphäre harmonisch verbindet.

THE GRID takes the modular principle of VALO to a new level: the system creates seamless transitions between buffet and table – delivering a coherent concept that harmoniously combines efficiency, design and atmosphere.

THE GRID lleva el principio modular de VALO a un nuevo nivel: el sistema crea transiciones fluidas entre el bufé y la mesa, dando lugar a un concepto continuo que combina de forma armoniosa eficiencia, diseño y ambiente.

THE GRID transpose le principe modulaire de VALO dans une nouvelle dimension : le système crée des transitions fluides entre le buffet et la table et développe un concept cohérent où efficacité, design et atmosphère s'unissent naturellement.

THE GRID

25 porcelain items, 6 glass items and 6 wood items – one fully combinable system, seamlessly compatible with VALO.

Diameter: cm 4,5 6 7,5 9* 12,5 14* 16

Height: cm

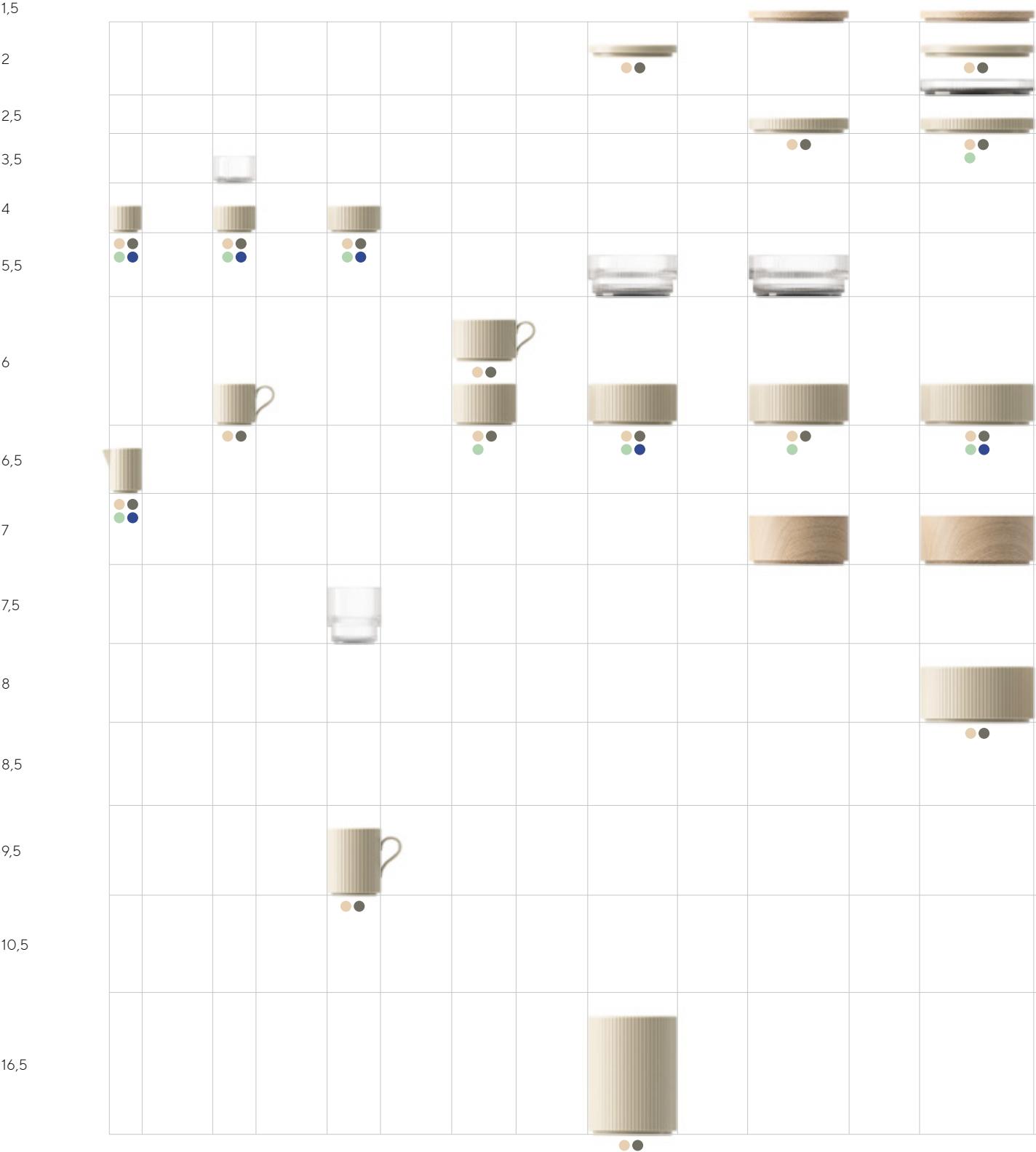

20**

23*

26**

32

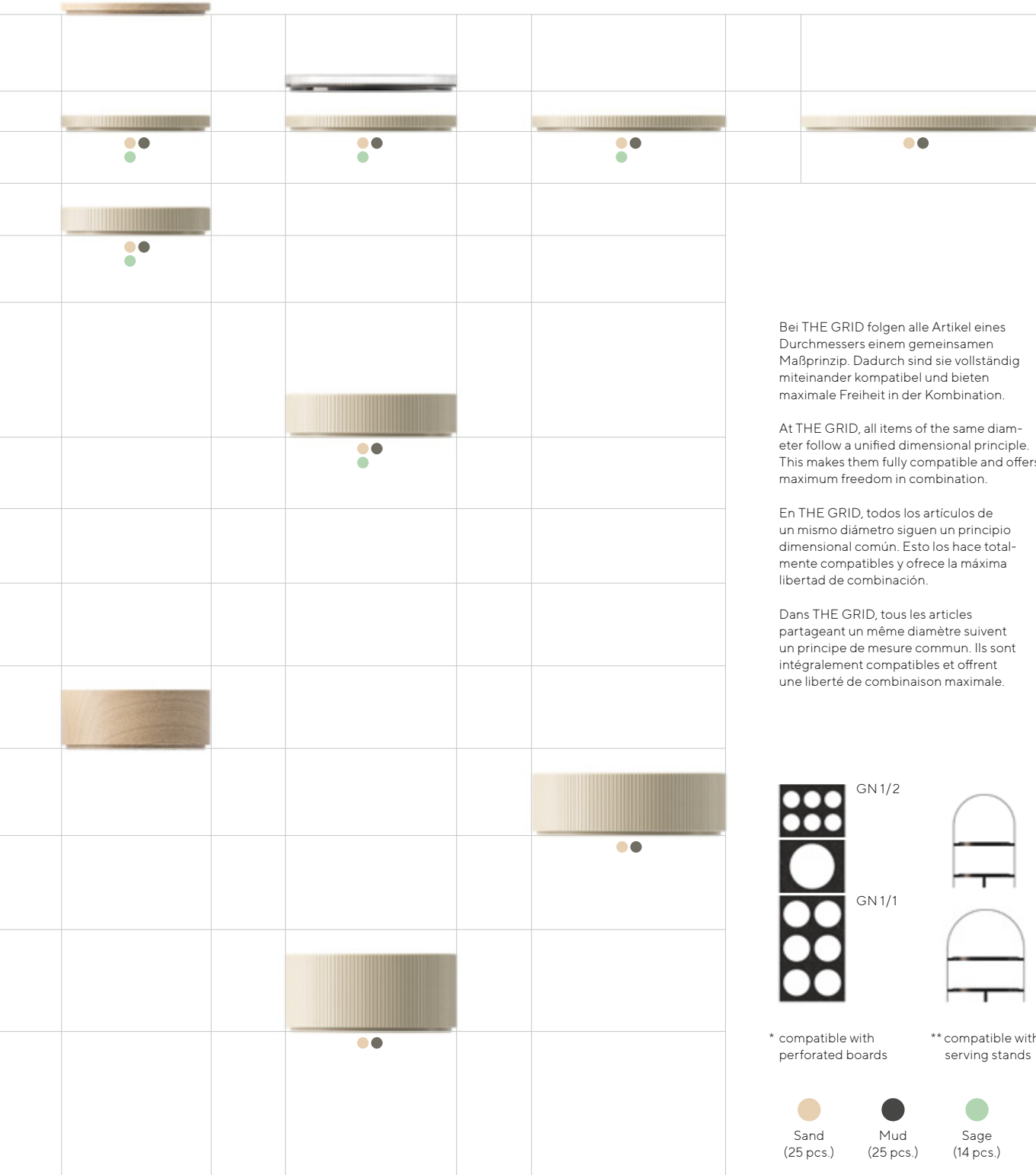

Bei THE GRID folgen alle Artikel eines Durchmessers einem gemeinsamen Maßprinzip. Dadurch sind sie vollständig miteinander kompatibel und bieten maximale Freiheit in der Kombination.

At THE GRID, all items of the same diameter follow a unified dimensional principle. This makes them fully compatible and offers maximum freedom in combination.

En THE GRID, todos los artículos de un mismo diámetro siguen un principio dimensional común. Esto los hace totalmente compatibles y ofrece la máxima libertad de combinación.

Dans THE GRID, tous les articles partageant un même diamètre suivent un principe de mesure commun. Ils sont intégralement compatibles et offrent une liberté de combinaison maximale.

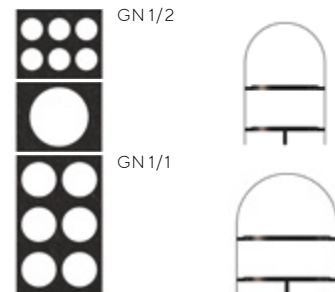

* compatible with perforated boards

** compatible with serving stands

- Sand
(25 pcs.)
- Mud
(25 pcs.)
- Sage
(14 pcs.)
- Marine
(6 pcs.)



Schale „THE GRID“

bowl
cuenco
bol



	∅ cm	↑ cm	ltr.	VE / unit	€ / pc.
19020	4,5	4,0	0,025	12	2,30



Schale „THE GRID“

bowl
cuenco
bol



	∅ cm	↑ cm	ltr.	VE / unit	€ / pc.
19022	6,0	4,0	0,045	12	4,00



Schale „THE GRID“

bowl
cuenco
bol



	∅ cm	↑ cm	ltr.	VE / unit	€ / pc.
19024	7,5	4,0	0,070	6	4,50

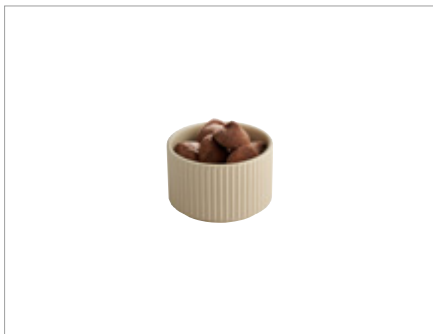

Schale „THE GRID“

bowl
cuenco
bol



	∅ cm	↑ cm	ltr.	VE / unit	€ / pc.
19027	9,0	6,0	0,20	6	5,50



Schale „THE GRID“

bowl
cuenco
bol



	∅ cm	↑ cm	ltr.	VE / unit	€ / pc.
19029	12,5	6,0	0,35	6	8,60
19030	12,5	16,5	1,30	-	24,00





Teller / Schale „THE GRID“

plate / bowl
plato / cuenco
assiette / bol



	Ø cm	↑ cm	ltr.	VE / unit	€ / pc.
19031	14,0	2,5	-	6	8,00
19032	14,0	6,0	0,45	6	10,80



Teller / Schale „THE GRID“

plate / bowl
plato / cuenco
assiette / bol



	Ø cm	↑ cm	ltr.	VE / unit	€ / pc.
19034	16,0	2,5	-	6	12,00
19035	16,0	6,0	0,55	6	14,00
19036	16,0	8,0	1,60	6	16,00



Teller / Schale „THE GRID“

plate / bowl
plato / cuenco
assiette / bol



	Ø cm	↑ cm	ltr.	VE / unit	€ / pc.
19037	20,0	2,5	-	6	13,00
19038	20,0	4,0	0,45	3	16,00



Teller / Schale „THE GRID“

plate / bowl
plato / cuenco
assiette / bol



	Ø cm	↑ cm	ltr.	VE / unit	€ / pc.
19039	23,0	2,5	-	3	17,00
19040	23,0	6,0	1,30	3	19,00
19041	23,0	10,5	2,50	-	35,00



Teller / Schale „THE GRID“

plate / bowl
plato / cuenco
assiette / bol



	Ø cm	↑ cm	ltr.	VE / unit	€ / pc.
19042	26,0	2,5	-	3	19,00
19043	26,0	8,5	2,50	-	39,00



Teller „THE GRID“

plate
plato
assiette



	Ø cm	↑ cm		VE / unit	€
19044	32,0	2,5		-	36,00



Gießer „THE GRID“

pouyer
vertedor
pichet



	Ø cm	↑ cm	ltr.	VE / unit	€ / pc.
19021	4,5	6,5	0,04	6	3,50



Espressotasse „THE GRID“

espresso cup
taza de espresso
tasse à espresso



	Ø cm	↑ cm	ltr.	VE / unit	€ / pc.
19023	6,0	6,0	0,08	6	4,20

Untertasse „THE GRID“

saucer
plattillo
soucoupe



	Ø cm	↑ cm	VE / unit	€ / pc.
19028	12,5	2,0	6	5,00



Kaffeebecher „THE GRID“

coffee mug
taza de café
tasse à café



	Ø cm	↑ cm	ltr.	VE / unit	€ / pc.
19025	7,5	9,5	0,24	6	6,20

Untertasse „THE GRID“

saucer
plattillo
soucoupe



	Ø cm	↑ cm	VE / unit	€ / pc.
19033	16,0	2,0	6	6,60



Cappuccinotasse „THE GRID“

cappuccino cup
taza de cappuccino
tasse à cappuccino



	Ø cm	↑ cm	ltr.	VE / unit	€ / pc.
19026	9,0	6,0	0,20	6	5,40

Untertasse „THE GRID“

saucer
plattillo
soucoupe



	Ø cm	↑ cm	VE / unit	€ / pc.
19033	16,0	2,0	6	6,60

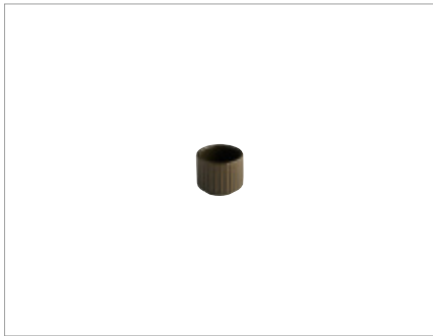

Schale „THE GRID“

bowl
cuenco
bol



	Ø cm	↑ cm	ltr.	VE / unit	€ / pc.
19060	4,5	4,0	0,025	12	2,30

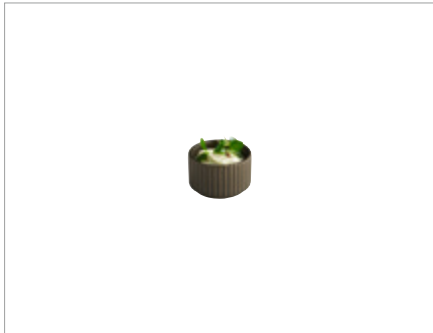

Schale „THE GRID“

bowl
cuenco
bol



	Ø cm	↑ cm	ltr.	VE / unit	€ / pc.
19062	6,0	4,0	0,045	12	4,00



Schale „THE GRID“

bowl
cuenco
bol



	Ø cm	↑ cm	ltr.	VE / unit	€ / pc.
19064	7,5	4,0	0,070	6	4,50

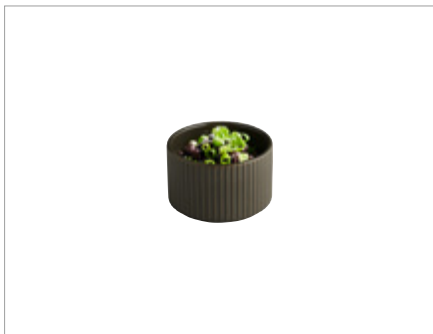

Schale „THE GRID“

bowl
cuenco
bol



	Ø cm	↑ cm	ltr.	VE / unit	€ / pc.
19067	9,0	6,0	0,20	6	5,50



Schale „THE GRID“

bowl
cuenco
bol



	Ø cm	↑ cm	ltr.	VE / unit	€ / pc.
19069	12,5	6,0	0,35	6	8,60
19070	12,5	16,5	1,30	-	24,00





Teller / Schale „THE GRID“

plate / bowl
plato / cuenco
assiette / bol



	Ø cm	↑ cm	ltr.	VE / unit	€ / pc.
19071	14,0	2,5	-	6	8,00
19072	14,0	6,0	0,45	6	10,80



Teller / Schale „THE GRID“

plate / bowl
plato / cuenco
assiette / bol



	Ø cm	↑ cm	ltr.	VE / unit	€ / pc.
19074	16,0	2,5	-	6	12,00
19075	16,0	6,0	0,55	6	14,00
19076	16,0	8,0	1,60	6	16,00



Teller / Schale „THE GRID“

plate / bowl
plato / cuenco
assiette / bol



	Ø cm	↑ cm	ltr.	VE / unit	€ / pc.
19077	20,0	2,5	-	6	13,00
19078	20,0	4,0	0,45	3	16,00



Teller / Schale „THE GRID“

plate / bowl
plato / cuenco
assiette / bol



	Ø cm	↑ cm	ltr.	VE / unit	€ / pc.
19079	23,0	2,5	-	3	17,00
19080	23,0	6,0	1,30	3	19,00
19081	23,0	10,5	2,50	-	35,00



Teller / Schale „THE GRID“

plate / bowl
plato / cuenco
assiette / bol



	Ø cm	↑ cm	ltr.	VE / unit	€ / pc.
19082	26,0	2,5	-	3	19,00
19083	26,0	8,5	2,50	-	39,00



Teller „THE GRID“

plate
plato
assiette



	Ø cm	↑ cm		VE / unit	€
19084	32,0	2,5		-	36,00



Gießer „THE GRID“

pouyer
vertedor
pichet



	Ø cm	↑ cm	ltr.	VE / unit	€ / pc.
19061	4,5	6,5	0,04	6	3,50



Espressotasse „THE GRID“

espresso cup
taza de espresso
tasse à espresso



	Ø cm	↑ cm	ltr.	VE / unit	€ / pc.
19063	6,0	6,0	0,08	6	4,20

Untertasse „THE GRID“

saucer
plattilo
soucoupe



	Ø cm	↑ cm	VE / unit	€ / pc.
19068	12,5	2,0	6	5,00



Kaffeebecher „THE GRID“

coffee mug
taza de café
tasse à café



	Ø cm	↑ cm	ltr.	VE / unit	€ / pc.
19065	7,5	9,5	0,24	6	6,20

Untertasse „THE GRID“

saucer
plattilo
soucoupe



	Ø cm	↑ cm	VE / unit	€ / pc.
19073	16,0	2,0	6	6,60



Cappuccinotasse „THE GRID“

cappuccino cup
taza de cappuccino
tasse à cappuccino



	Ø cm	↑ cm	ltr.	VE / unit	€ / pc.
19066	9,0	6,0	0,20	6	5,40

Untertasse „THE GRID“

saucer
plattilo
soucoupe



	Ø cm	↑ cm	VE / unit	€ / pc.
19073	16,0	2,0	6	6,60



Schale „THE GRID“

bowl
cuenco
bol



	Ø cm	↑ cm	ltr.	VE / unit	€ / pc.
19100	4,5	4,0	0,025	12	2,30



Gießer „THE GRID“

pourer
vertedor
pichet



	Ø cm	↑ cm	ltr.	VE / unit	€ / pc.
19101	4,5	6,5	0,04	6	3,50



Schale „THE GRID“

bowl
cuenco
bol



	Ø cm	↑ cm	ltr.	VE / unit	€ / pc.
19102	6,0	4,0	0,045	12	4,00

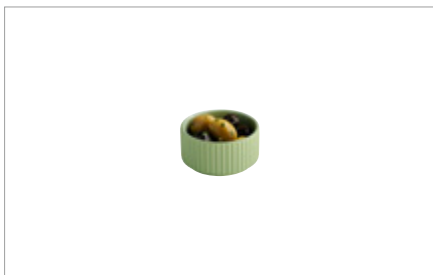

Schale „THE GRID“

bowl
cuenco
bol



	Ø cm	↑ cm	ltr.	VE / unit	€ / pc.
19104	7,5	4,0	0,070	6	4,50



Schale „THE GRID“

bowl
cuenco
bol



	Ø cm	↑ cm	ltr.	VE / unit	€ / pc.
19107	9,0	6,0	0,20	6	5,50



Schale „THE GRID“

bowl
cuenco
bol



	Ø cm	↑ cm	ltr.	VE / unit	€ / pc.
19109	12,5	6,0	0,35	6	8,60



Schale „THE GRID“

bowl
cuenco
bol



	Ø cm	↑ cm	ltr.	VE / unit	€ / pc.
19112	14,0	6,0	0,45	6	10,80



Teller / Schale „THE GRID“

plate / bowl
plato / cuenco
assiette / bol



	Ø cm	↑ cm	ltr.	VE / unit	€ / pc.
19114	16,0	2,5	-	6	12,00
19115	16,0	6,0	0,55	6	14,00



Teller / Schale „THE GRID“

plate / bowl
plato / cuenco
assiette / bol



	Ø cm	↑ cm	ltr.	VE / unit	€ / pc.
19117	20,0	2,5	-	6	13,00
19118	20,0	4,0	0,45	3	16,00



Teller / Schale „THE GRID“

plate / bowl
plato / cuenco
assiette / bol



	Ø cm	↑ cm	ltr.	VE / unit	€ / pc.
19119	23,0	2,5	-	3	17,00
19120	23,0	6,0	1,30	3	19,00



Teller „THE GRID“

plate bowl
plato cuenco
assiette bol



	Ø cm	↑ cm	VE / unit	€ / pc.
19122	26,0	2,5	3	19,00



Schale „THE GRID“

bowl
cuenco
bol



	Ø cm	↑ cm	ltr.	VE / unit	€ / pc.
19140	4,5	4,0	0,025	12	2,30

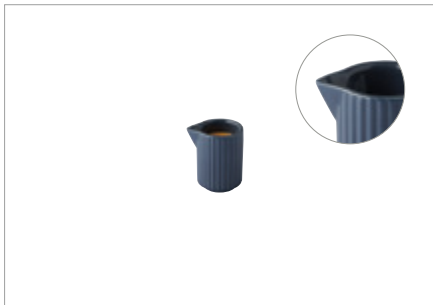

Gießer „THE GRID“

pourer
vertedor
pichet



	Ø cm	↑ cm	ltr.	VE / unit	€ / pc.
19141	4,5	6,5	0,04	6	3,50



Schale „THE GRID“

bowl
cuenco
bol



	Ø cm	↑ cm	ltr.	VE / unit	€ / pc.
19142	6,0	4,0	0,045	12	4,00



Schale „THE GRID“

bowl
cuenco
bol



	Ø cm	↑ cm	ltr.	VE / unit	€ / pc.
19144	7,5	4,0	0,070	6	4,50



Schale „THE GRID“

bowl
cuenco
bol



	Ø cm	↑ cm	ltr.	VE / unit	€ / pc.
19149	12,5	6,0	0,35	6	8,60



Schale „THE GRID“

bowl
cuenco
bol



	Ø cm	↑ cm	ltr.	VE / unit	€ / pc.
19155	16,0	6,0	0,55	6	14,00



Schale „THE GRID“

bowl
cuenco
bol



	Ø cm	↑ cm	ltr.	VE / unit	€ / pc.
19000	6,0	3,5	0,045	12	3,20



Trinkglas „THE GRID“

drinking glass
vaso de agua
verre à boire



	Ø cm	↑ cm	ltr.	VE / unit	€ / pc.
19001	7,5	7,5	0,175	6	4,20



Schale „THE GRID“

bowl
cuenco
bol



	Ø cm	↑ cm	ltr.	VE / unit	€ / pc.
19002	12,5	5,5	0,35	12	6,00



Schale „THE GRID“

bowl
cuenco
bol



	Ø cm	↑ cm	ltr.	VE / unit	€ / pc.
19003	14,0	5,5	0,45	6	8,80



Teller „THE GRID“

plate
plato
assiette



	Ø cm	↑ cm	VE / unit	€ / pc.
19004	16,0	2,0	6	8,00



Teller „THE GRID“

plate
plato
assiette







	Ø cm	↑ cm	VE / unit	€ / pc.
19005	23,0	2,0	6	10,00



Teller / Schale „THE GRID“
 plate / bowl
 plato / cuenco
 assiette / bol

Eichenholz (geölt) / oak wood (oiled) / madera de roble (aceitada) / chêne (huilé)











	Ø cm	↑ cm	ltr.	€
19010	14,0	1,5	-	16,50
19011	14,0	7,0	0,55	38,00



Teller / Schale „THE GRID“
 plate / bowl
 plato / cuenco
 assiette / bol

Eichenholz (geölt) / oak wood (oiled) / madera de roble (aceitada) / chêne (huilé)





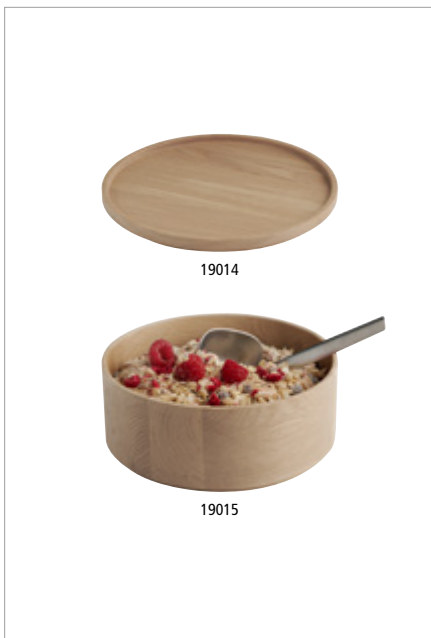





	Ø cm	↑ cm	ltr.	€
19012	16,0	1,5	-	19,50
19013	16,0	7,0	0,72	41,00



Teller / Schale „THE GRID“
 plate / bowl
 plato / cuenco
 assiette / bol

Eichenholz (geölt) / oak wood (oiled) / madera de roble (aceitada) / chêne (huilé)

	Ø cm	↑ cm	ltr.	€
19014	20,0	1,5	-	24,00
19015	20,0	8,0	1,5	59,00

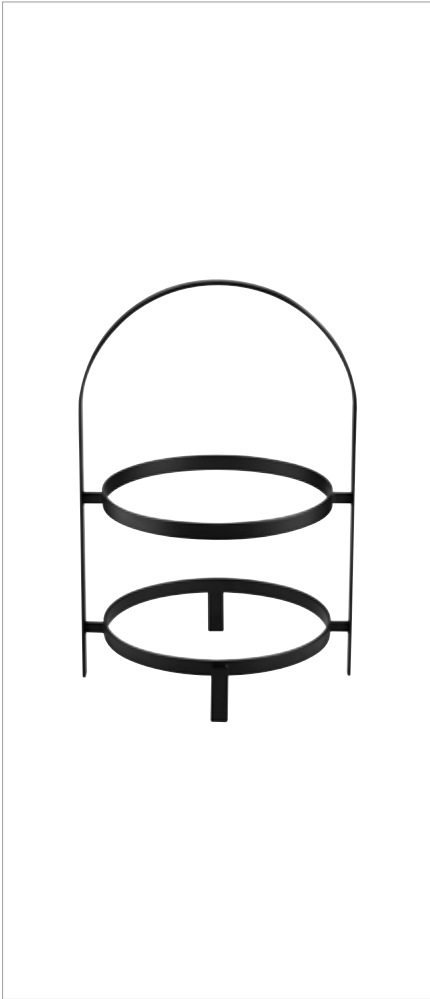

Serviergestell „THE GRID“

serving stand
soporte platos
présentoir à assiettes



kompatibel mit allen Artikeln der Serie „THE GRID“ mit Ø 20 cm

compatible with all items in the „THE GRID“ series with a Ø 20 cm

compatible con todos los artículos de la serie „THE GRID“ con un Ø de 20 cm

compatible avec tous les articles de la série „THE GRID“ d'un Ø de 20 cm

	cm	↑ cm	€
19180	23,5 x 20,5	35,5	25,00

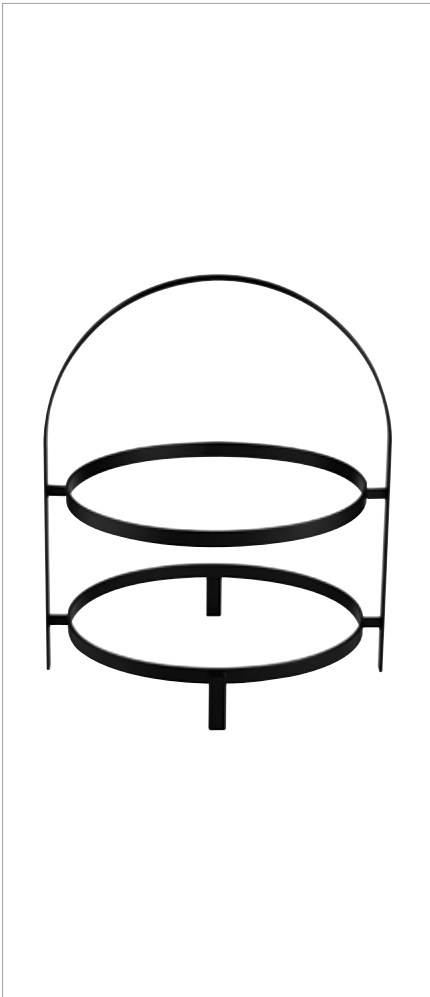

Serviergestell „THE GRID“

serving stand
soporte platos
présentoir à assiettes



kompatibel mit allen Artikeln der Serie „THE GRID“ mit Ø 26 cm

compatible with all items in the „THE GRID“ series with a Ø 26 cm

compatible con todos los artículos de la serie „THE GRID“ con un Ø de 26 cm

compatible avec tous les articles de la série „THE GRID“ d'un Ø de 26 cm

	cm	↑ cm	€
19181	29,5 x 26,5	35,5	29,00



NEW

THE GRID COOLING



GN 1/1 Naturschieferplatte

GN 1/1 natural slate tray
GN 1/1 bandeja de pizarra natural
GN 1/1 plat ardoise naturelle



kompatibel mit allen Artikeln der Serie „THE GRID“ mit Ø 14 cm

compatible with all items in the „THE GRID“ series with a Ø 14 cm

compatible con todos los artículos de la serie „THE GRID“ con un Ø de 14 cm

compatible avec tous les articles de la série „THE GRID“ d'un Ø de 14 cm

	cm	✦ mm	GN	fits to	€
19185	53,0 x 32,5	6-9	1/1	VALO GN 1/1	16,80



GN 1/2 Naturschieferplatte

GN 1/2 natural slate tray
GN 1/2 bandeja de pizarra natural
GN 1/2 plat ardoise naturelle



kompatibel mit allen Artikeln der Serie „THE GRID“ mit Ø 23 cm

compatible with all items in the „THE GRID“ series with a Ø 23 cm

compatible con todos los artículos de la serie „THE GRID“ con un Ø de 23 cm

compatible avec tous les articles de la série „THE GRID“ d'un Ø de 23 cm

	cm	✦ mm	GN	fits to	€
19186	32,5 x 26,5	6-9	1/2	VALO GN 1/2, GN 1/1	12,00





GN 1/2 Naturschieferplatte

GN 1/2 natural slate tray
GN 1/2 bandeja de pizarra natural
GN 1/2 plat ardoise naturelle



kompatibel mit allen Artikeln der Serie „THE GRID“ mit Ø 9 cm

compatible with all items in the „THE GRID“ series with a Ø 9 cm

compatible con todos los artículos de la serie „THE GRID“ con un Ø de 9 cm

compatible avec tous les articles de la série „THE GRID“ d'un Ø de 9 cm

	cm	✂ mm	GN	fits to	€
19187	32,5 x 26,5	6-9	1/2	VALO GN 1/2, GN 1/1	12,00



Kühlakku

cooler
acumulador de frío
accumulateur de froid



	cm	↑ cm	fits to	€
10791	25 x 19	2,5	14078	8,40



GN 1/2 Einsatz „VALO“

GN 1/2 insert
GN 1/2 inserto
GN 1/2 insert



	cm	↑ cm	fits to	€
14078	30 x 24	4	VALO GN 1/2, GN 1/1 with height: 8,5 cm	13,00

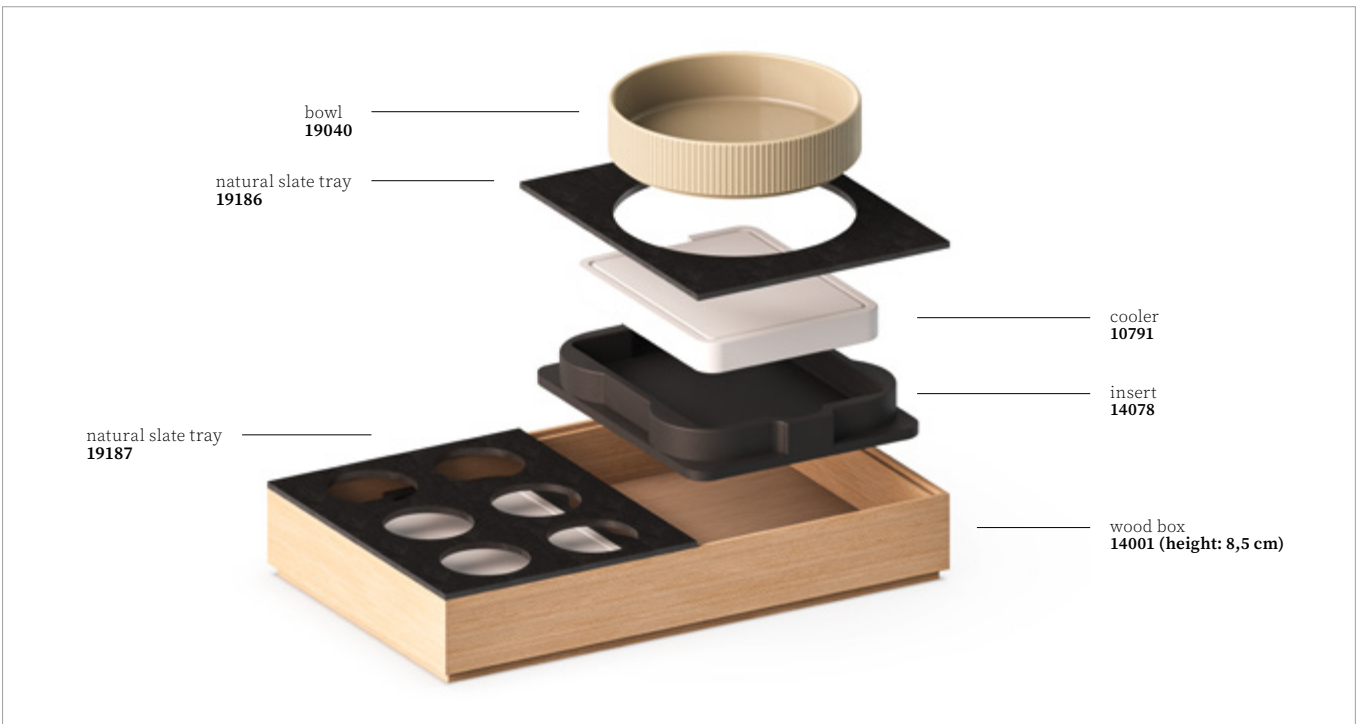

THE GRID x VALO



GN 1/1 Holzbox „VALO“

GN 1/1 woodbox
GN 1/1 caja madera
GN 1/1 base bois

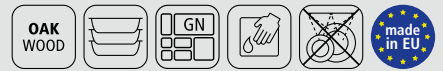

	cm	↑ cm	GN	Farbe / colour	€
14000	53 x 32,5	4,5	1/1	(oiled)	76,00
14001	53 x 32,5	8,5	1/1	(oiled)	92,00
14002	53 x 32,5	16,5	1/1	(oiled)	136,00

Kompatibel mit den Naturschieferplatten Nr. 19185, 19186 und 19187.
Die Kombination mit dem Kühlsystem (Einsatz Nr. 14078 + Kühlakku Nr. 10791) passt nur in VALO-Boxen mit der Höhe 8,5 cm.

Compatible with natural slate plates no. 19185, 19186 and 19187.
The combination with the cooling system (insert no. 14078 + cooling pack no. 10791) only fits VALO boxes with height 8,5 cm.



GN 1/1 Holzbox „VALO“

GN 1/1 woodbox
GN 1/1 caja madera
GN 1/1 base bois



	cm	↑ cm	GN	Farbe / colour	€
14100	53 x 32,5	4,5	1/1	(lacquered)	84,00
14101	53 x 32,5	8,5	1/1	(lacquered)	100,00
14102	53 x 32,5	16,5	1/1	(lacquered)	148,00

Kompatibel mit den Naturschieferplatten Nr. 19185, 19186 und 19187.
Die Kombination mit dem Kühlsystem (Einsatz Nr. 14078 + Kühlakku Nr. 10791) passt nur in VALO-Boxen mit der Höhe 8,5 cm.

Compatible with natural slate plates no. 19185, 19186 and 19187.
The combination with the cooling system (insert no. 14078 + cooling pack no. 10791) only fits VALO boxes with height 8,5 cm.





GN 1/2 Holzbox „VALO“

GN 1/2 woodbox
GN 1/2 caja madera
GN 1/2 base bois



	cm	↑ cm	GN	Farbe / colour	€
14003	32,5 x 26,5	4,5	1/2	(oiled)	54,00
14004	32,5 x 26,5	8,5	1/2	(oiled)	66,00
14005	32,5 x 26,5	16,5	1/2	(oiled)	92,00

Kompatibel mit den Naturschieferplatten Nr. 19186 und 19187.
Die Kombination mit dem Kühlsystem (Einsatz Nr. 14078 + Kühlakku Nr. 10791) passt nur in VALO-Boxen mit der Höhe 8,5 cm.

Compatible with natural slate plates no. 19186 and 19187.
The combination with the cooling system (insert no. 14078 + cooling pack no. 10791) only fits VALO boxes with height 8,5 cm.



GN 1/2 Holzbox „VALO“

GN 1/2 woodbox
GN 1/2 caja madera
GN 1/2 base bois



	cm	↑ cm	GN	Farbe / colour	€
14103	32,5 x 26,5	4,5	1/2	(lacquered)	59,00
14104	32,5 x 26,5	8,5	1/2	(lacquered)	72,00
14105	32,5 x 26,5	16,5	1/2	(lacquered)	100,00

Kompatibel mit den Naturschieferplatten Nr. 19186 und 19187.
Die Kombination mit dem Kühlsystem (Einsatz Nr. 14078 + Kühlakku Nr. 10791) passt nur in VALO-Boxen mit der Höhe 8,5 cm.

Compatible with natural slate plates no. 19186 and 19187.
The combination with the cooling system (insert no. 14078 + cooling pack no. 10791) only fits VALO boxes with height 8,5 cm.



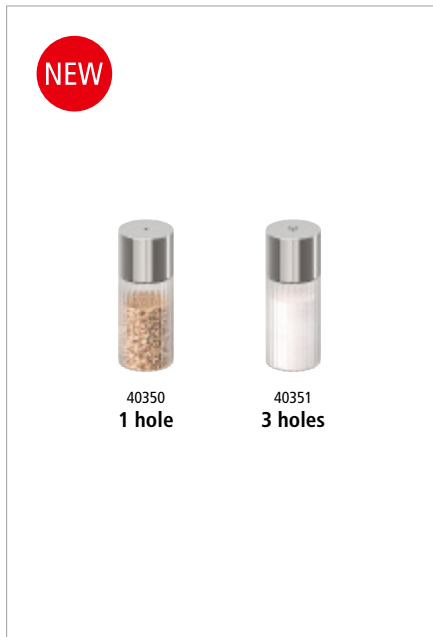

Salz- / Pfefferstreuer „THE GRID“

salt / pepper shaker
salero / pimentero
salière / poivrière



	Ø cm	↑ cm	ltr.		€
40350	3,5	9	0,04	1 hole – Ø 2 mm	3,80
40351	3,5	9	0,04	3 holes – Ø 2 mm	3,80



Essig- & Öl-Flasche „THE GRID“

oil- and vinegar bottle
botella de aceite y vinagre
bouteille d'huile et vinaigre



mit Deckel und integriertem Dosierrohr für ein präzises und kontrolliertes Ausgießen
with lid and integrated measuring tube for precise and controlled pouring
con tapa y tubo dosificador integrado para un vertido preciso y controlado
avec couvercle et tube doseur intégré pour un versement précis et contrôlé

	Ø cm	↑ cm	ltr.		€
40352	6	15,5	0,2		7,50



Zuckerdosierer „THE GRID“

sugar dispenser
azucarero
sucrier



mit integriertem Dosierrohr für ein präzises und kontrolliertes Portionieren
with integrated measuring tube, for precise and controlled portioning
con tubo dosificador integrado para un dosificado preciso y controlado
avec tube doseur intégré pour un dosage précis et contrôlé

	Ø cm	↑ cm	ltr.		€
40353	6	17	0,2		6,50





Allzweckgießer „THE GRID“

pourer
bote vertedor universal
pot verseur universel
ideal für Kaffeesahne und Milch
ideal for cream and milk
ideal para crema y leche
idéal pour la crème et le lait



	Ø cm	↑ cm	ltr.	€
40354	6	15,5	0,2	6,00



Menage „THE GRID“

menage
menage
ménage



Metall matt-schwarz, perfekt zur Präsentation von Essig & Öl sowie Milch & Zucker
metal matte black, perfect for presenting vinegar & oil as well as milk & sugar
metal negro mate, perfecto para presentar vinagre y aceite, así como leche y azúcar
métal noir mat, parfait pour présenter le vinaigre et l'huile ainsi que le lait et le sucre

	cm	↑ cm	fits to	€
40358	14,5 x 7	30	40352, 40353, 40354	14,00



Menage „THE GRID“

menage
menage
ménage



Metall matt-schwarz, perfekt zur Präsentation von Essig & Öl, Milch & Zucker sowie Gewürzen
metal matte black, perfect for presenting vinegar & oil, milk & sugar, as well as spices
metal negro mate, perfecto para presentar vinagre y aceite, leche y azúcar, así como especias
métal noir mat, parfait pour présenter le vinaigre et l'huile, le lait et le sucre, ainsi que des épices

	cm	↑ cm	fits to	€
40359	14,5 x 10,5	30	40350, 40351, 40352, 40353, 40354	16,00



PERFECTO



Buffetständer „PERFECTO“

buffet stand
soporte para buffet
présentoir buffet



Gestell aus Metall mit schwarzer Antirutschbeschichtung
metal frame with black anti-slide coating
soporte de metal con revestimiento antideslizante negro
structure en métal avec revêtement antidérapant noir

	cm	↑ cm	fits to	€
33304	23 x 19	40,5	33302, 33303	25,00
33308 <small>NEW</small>	23 x 19	59,5	33302, 33303	28,00



Buffetbrett „PERFECTO“

buffet board
tabla de buffet
planche de buffet



	cm	↑ cm	fits to	€
33302	20 x 20	2	33304, 33308	16,40
33303	80 x 20	2	33304, 33308	62,00

3 tlg.
3 pcs.



2-stufige Etagère „PERFECTO SMALL“

2-tier tray
bandeja dos alturas
étagère carré 2 hauteurs



3-teiliges Set, bestehend aus:

- 1 Buffetständer aus Metall mit schwarzer Antirutschbeschichtung, 23 x 19 cm, H: 40,5 cm
- 2 Bretter aus Eichenholz, geölt, 20 x 20 cm, H: 2 cm

3 pcs., consisting of:

- 1 buffet stand, metal with black anti-slide coating, 23 x 19 cm, h: 40,5 cm
- 2 boards, oiled oak, 20 x 20 cm, h: 2 cm

set de 3, compuesto por:

- 1 soporte para buffet, metal con revestimiento antideslizante negro, 23 x 19 cm, a: 40,5 cm
- 2 tablas de roble, aceitadas, 20 x 20 cm, a: 2 cm

set de 3, composé de :

- 1 présentoir buffet, métal avec revêtement antidérapant noir, 23 x 19 cm, h: 40,5 cm
- 2 planches en bois de chêne, huilées, 20 x 20 cm, h: 2 cm

	cm	↑ cm	€
33300	23 x 20	40,5	56,80

4 tlg.
4 pcs.



2-stufige Etagère „PERFECTO LARGE“

2-tier tray
bandeja dos alturas
étagère carré 2 hauteurs



4-teiliges Set, bestehend aus:

- 2 Buffetständer aus Metall mit schwarzer Antirutschbeschichtung, 23 x 19 cm, H: 40,5 cm
- 2 Bretter aus Eichenholz, geölt, 80 x 20 cm, H: 2 cm

4 pcs., consisting of:

- 2 buffet stands, metal with black anti-slide coating, 23 x 19 cm, h: 40,5 cm
- 2 boards, oiled oak, 80 x 20 cm, h: 2 cm

set de 4, compuesto por:

- 2 soportes para buffet, metal con revestimiento antideslizante negro, 23 x 19 cm, a: 40,5 cm
- 2 tablas de roble, aceitadas, 80 x 20 cm, a: 2 cm

set de 4, composé de :

- 2 présentoirs buffet, métal avec revêtement antidérapant noir, 23 x 19 cm, h: 40,5 cm
- 2 planches en bois de chêne, huilées, 80 x 20 cm, h: 2 cm

	cm	↑ cm	€
33301	80 x 23	40,5	170,00



33304 33303 33304 33303 33304



33308
33302
33302
33302



93286 with decorative surface

93291 with decorative surface

Dosierspender „DISPENSA“

dosing dispenser
dosificador
distributeur de dosage



Behälter aus Glas, ideal zum Dosieren von Marmelade, Joghurt und Saucen (ohne Stücke / Fruchtfleisch)
glass container, ideal for dosing jam, yoghurt and sauces (without pieces / pulp)
recipiente de cristal, ideal para dosificar mermelada, yogur y salsas (sin trozos / pulpa)
récipient en verre, idéal pour doser la confiture, le yaourt et les sauces (sans morceaux / pulpe)

	Ø cm	↑ cm	ltr.	€
93286	10	27	1,0	20,00
93291	13	27	1,7	26,00

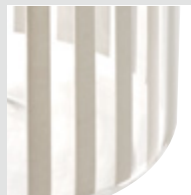

Hubvolumen 15 ml
stroke volume 15 ml



93286

14170



93285

93290

Dosierspender „DISPENSA“

dosing dispenser
dosificador
distributeur de dosage



Behälter aus Glas, ideal zum Dosieren von Marmelade, Joghurt und Saucen (ohne Stücke / Fruchtfleisch)
glass container, ideal for dosing jam, yoghurt and sauces (without pieces / pulp)
recipiente de cristal, ideal para dosificar mermelada, yogur y salsas (sin trozos / pulpa)
récipient en verre, idéal pour doser la confiture, le yaourt et les sauces (sans morceaux / pulpe)

	Ø cm	↑ cm	ltr.	€
93285 NEW	10	27	1,0	19,00
93290	13	27	1,7	24,00



Hubvolumen 15 ml
stroke volume 15 ml



93285

14170

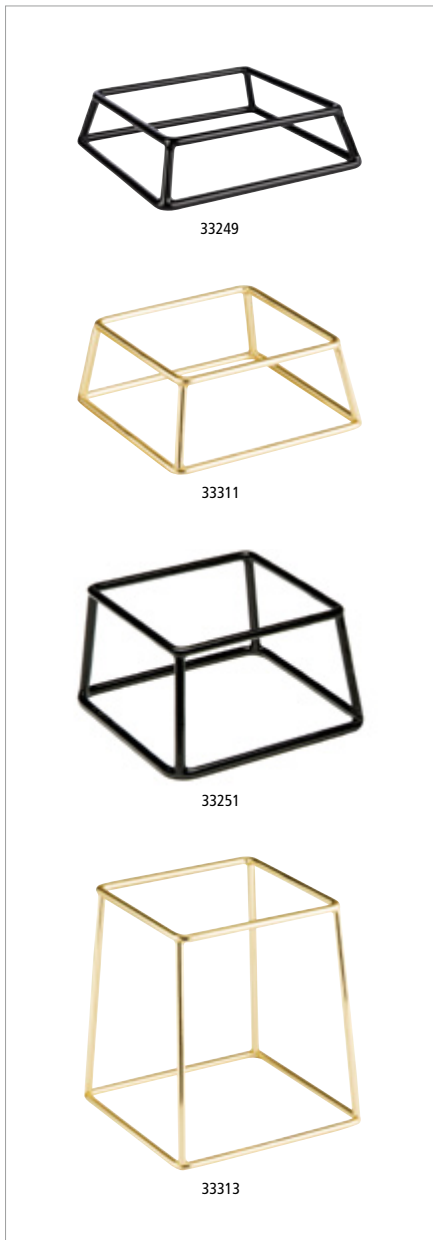

Buffetständer „MULTI“

buffet stand
soporte para buffet
présentoir buffet



die Kombination verschiedener Höhen erzeugt eine ansprechende Tiefe auf dem Buffet
the combination of different heights creates an appealing depth on the buffet
la combinación de diferentes alturas crea una profundidad atractiva en el buffet
la combinaison de différentes hauteurs crée une profondeur attrayante sur le buffet

	cm	↑ cm	Farbe / colour	€
33249	18 x 18	5	■ black	9,60
33250	18 x 18	8	■ black	13,20
33251	18 x 18	10	■ black	16,00
33252	18 x 18	20	■ black	18,90
33310 <small>NEW</small>	18 x 18	5	■ gold	10,80
33311 <small>NEW</small>	18 x 18	8	■ gold	14,20
33312 <small>NEW</small>	18 x 18	10	■ gold	17,00
33313 <small>NEW</small>	18 x 18	20	■ gold	20,00

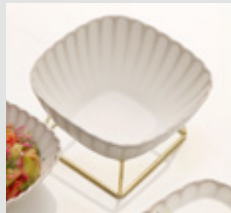

mit Antirutschbeschichtung
with anti-slide coating



Buffetständer „MULTI“

buffet stand
soporte para buffet
présentoir buffet



die Kombination verschiedener Höhen erzeugt eine ansprechende Tiefe auf dem Buffet
the combination of different heights creates an appealing depth on the buffet
la combinación de diferentes alturas crea una profundidad atractiva en el buffet
la combinaison de différentes hauteurs crée une profondeur attrayante sur le buffet

	Ø cm	↑ cm	Farbe / colour	€
33269	15,5 / 18	8	■ black	10,90
33270	15,5 / 18	10	■ black	13,00
33271	15,5 / 18	18	■ black	16,70



mit Antirutschbeschichtung
with anti-slide coating

MANGO



Schale „MANGO“

bowl
cuenco
bol



handgefertigte Schale mit edler, innenliegender Epoxidharzbeschichtung

handmade bowl with a refined inner epoxy resin coating

cuenco hecho a mano con un elegante revestimiento interior de resina epoxi

bol fabriqué à la main avec un élégant revêtement intérieur en résine époxy

	Ø cm	↑ cm	ltr.	€
01050	20	7,5	0,8	21,00
01053	24	7,5	1,1	25,00
01056	30	10,5	3,0	35,00
01057	37	9,0	4,0	35,00



Tablett / Teller „MANGO“

tray / plate
bandeja / plato
plateau / assiette



handgefertigter Teller mit edler, innenliegender Epoxidharzbeschichtung

handmade plate with a refined inner epoxy resin coating

plato hecho a mano con un elegante revestimiento interior de resina epoxi

assiette fabriquée à la main avec un élégant revêtement intérieur en résine époxy

	Ø cm	↑ cm	€
01058	35,5	2,5	32,00

NEW



01060



01062

Schale „MANGO“

bowl
cuenco
bol

handgefertigte Schale mit edler, innenliegender Epoxidharzbeschichtung

handmade bowl with a refined inner epoxy resin coating

cuenco hecho a mano con un elegante revestimiento interior de resina epoxi

bol fabriqué à la main avec un élégant revêtement intérieur en résine époxy

	Ø cm	↑ cm	ltr.	€
01060	20	7,5	0,8	21,00
01062	30	10,5	3,0	35,00



Schale „MANGO“

bowl
cuenco
bol

handgefertigte Schale mit edler, innenliegender Epoxidharzbeschichtung

handmade bowl with a refined inner epoxy resin coating

cuenco hecho a mano con un elegante revestimiento interior de resina epoxi

bol fabriqué à la main avec un élégant revêtement intérieur en résine époxy

	Ø cm	↑ cm	ltr.	€
01051	24	7,5	1,1	25,00
01054	30	10,5	3,0	35,00

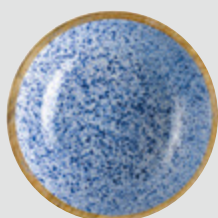

01051



01054



TERRAZZO



NEW



30080



30081



30082

Schale „TERRAZZO“

bowl
cuenco
bol

Terrazzooptik

terrazzo look

aspecto terrazo

optique terrazzo



	Ø cm	↑ cm	ltr.	€
30080	22,0	6,0 / 10,5	1,1	24,00
30081	26,0	7,5 / 13,0	1,7	31,00
30082	29,5	8,5 / 14,5	2,5	36,00

Farb- und Strukturabweichungen möglich
colour and texture variations possible

NEW



Dose, 2er Set „TERRAZZO“

container, 2 pcs.
recipiente, set de 2
boîte, set de 2



ideal zum Servieren von Aufstrichen, Butter, Gewürzen oder kleinen Delikatessen

ideal for serving spreads, butter, spices, or small delicacies

ideal para servir untables, mantequilla, especias o pequeñas delicias

idéal pour servir des tartinades, du beurre, des épices ou de petites gourmandises

	Ø cm	↑ cm	ml	€
15917	6	5	40	15,00

Farb- und Strukturabweichungen möglich
colour and texture variations possible



Flaschenkühler „TERRAZZO“

bottle cooler
enfriador de botella
rafraîchisseur de bouteille



Terrazzooptik

terrazzo look

aspecto terrazo

optique terrazzo

	Ø cm	↑ cm	€
36150	12,5 / 10	19	20,00

Farb- und Strukturabweichungen möglich
colour and texture variations possible



Besteckbehälter „TERRAZZO“

cutlery bin
recipiente para cubiertos
récipients pour couverts



Terrazzooptik, mit Abflussloch, Bodeneinlage aus Silikon zum Schonen des Bestecks

terrazzo look, with drain hole, silicone floor insert for saving the points of knives

aspecto terrazo, con orificio de drenaje, soporte de silicona para proteger las puntas de los cuchillos

optique terrazzo, avec le trou de drainage, insert de silicone pour protéger les pointes des couteaux

	Ø cm	↑ cm	€
11760	11	13,5	17,00

Farb- und Strukturabweichungen möglich
colour and texture variations possible



NEW BULQ



75946



75947



75948



Löffel „BULQ“

spoon
cuchara
cuillère

18/8
STAINLESS
STEEL



die angeschrägte Form sorgt für eine komfortable Entnahme und ein sauberes Servieren
the bevelled shape ensures easy removal and clean serving
la forma biselada facilita la extracción y el servicio limpio
la forme biseautée permet un prélèvement confortable et un service propre

	cm	→ cm	ml	Farbe / colour	€
75946	8,5 x 8,5	23	120	 vintage-look	10,00
75947	8,5 x 8,5	23	120	 vintage-look gold (PVD)	11,00
75948	8,5 x 8,5	23	120	 vintage-look copper (PVD)	11,00

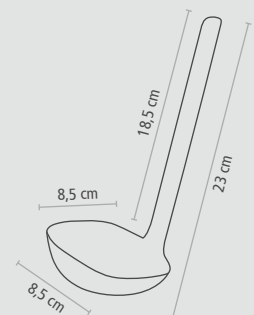



Löffel, 2er Set „BULQ“

spoon, set of 2
cuchara, set de 2
cuillère, set de 2



die angeschrägte Form sorgt für eine komfortable Entnahme und ein sauberes Servieren
the bevelled shape ensures easy removal and clean serving
la forma biselada facilita la extracción y el servicio limpio
la forme biseautée permet un prélèvement confortable et un service propre

	cm	→ cm	ml	Farbe / colour		pcs.	€/ set
75943	6,5 x 6,5	17,5	60		vintage-look	2	13,60
75944	6,5 x 6,5	17,5	60		vintage-look gold (PVD)	2	15,00
75945	6,5 x 6,5	17,5	60		vintage-look copper (PVD)	2	15,00

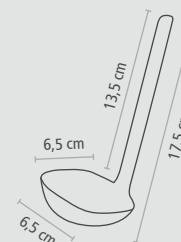
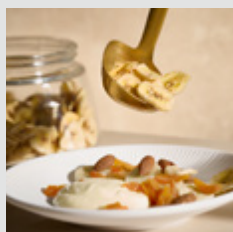

Löffel, 4er Set „BULQ“

spoon, set of 4
cuchara, set de 4
cuillère, set de 4



die angeschrägte Form sorgt für eine komfortable Entnahme und ein sauberes Servieren
the bevelled shape ensures easy removal and clean serving
la forma biselada facilita la extracción y el servicio limpio
la forme biseautée permet un prélèvement confortable et un service propre

	cm	→ cm	ml	Farbe / colour		pcs.	€/ set
75940	4,5 x 4,5	12,5	20		vintage-look	4	16,50
75941	4,5 x 4,5	12,5	20		vintage-look gold (PVD)	4	18,00
75942	4,5 x 4,5	12,5	20		vintage-look copper (PVD)	4	18,00



FROSTFIRE

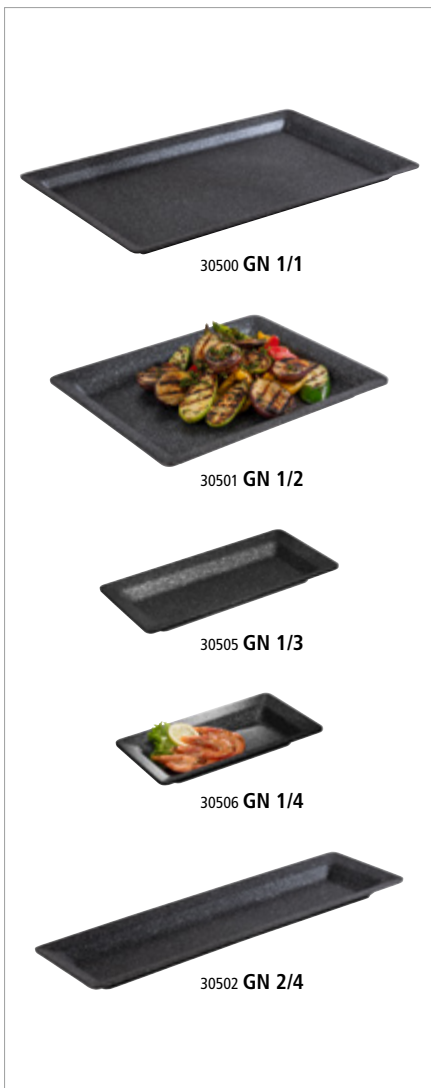

GN Tablett „FROSTFIRE“

GN tray
GN bandeja
GN plateau



Antihftbeschichtung / non stick coating / antiadherente / revêtement anti-adhésif

	cm	↑ cm	GN	Farbe / colour	€
30500	53,0 x 32,5	3	1/1	black / silver	57,00
30501	32,5 x 26,5	3	1/2	black / silver	40,00
30505	32,5 x 17,6	3	1/3	black / silver	30,00
30506	26,5 x 16,2	3	1/4	black / silver	26,00
30502	53,0 x 16,2	3	2/4	black / silver	42,00

GN 1/1	GN 1/2	GN 1/3	GN 2/4	GN 1/4
	GN 1/2	GN 1/3		GN 1/4

2 Höhen – 4,5 und 7,5 cm
2 heights – 4,5 and 7,5 cm



30514
GN 1/1 – 4,5 cm



30507
GN 1/2 – 7,5 cm



30511
GN 1/4 – 4,5 cm



30516
GN 1/6 – 7,5 cm



30513
GN 2/4 – 4,5 cm

GN Schale „FROSTFIRE“

GN bowl
GN cuenco
GN bol



Antihafbeschichtung / non stick coating / antiadherente / revêtement anti-adhésif

	cm	↑ cm	ltr.	GN	Farbe / colour	€
30514 NEW	53,0 x 32,5	4,5	4,5	1/1	black / silver	74,00
30512 NEW	32,5 x 26,5	4,5	2,4	1/2	black / silver	44,00
30511 NEW	26,5 x 16,2	4,5	1,0	1/4	black / silver	30,00
30513 NEW	53,0 x 16,2	4,5	2,1	2/4	black / silver	45,00

	cm	↑ cm	ltr.	GN	Farbe / colour	€
30515 NEW	53,0 x 32,5	7,5	9,0	1/1	black / silver	82,00
30507	32,5 x 26,5	7,5	4,5	1/2	black / silver	48,00
30508	26,5 x 16,2	7,5	2,0	1/4	black / silver	37,00
30516 NEW	17,6 x 16,2	7,5	1,3	1/6	black / silver	32,00
30509	53,0 x 16,2	7,5	4,25	2/4	black / silver	52,00



Schale „FROSTFIRE“

bowl
cuenco
bol



Antihafbeschichtung / non stick coating / antiadherente / revêtement anti-adhésif

	Ø cm	↑ cm	ltr.	Farbe / colour	€
30510	45	10	5,6	black / silver	84,00

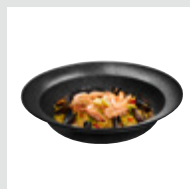



Schale „FROSTFIRE“

bowl
cuenco
bol



Antihafbeschichtung / non stick coating / antiadherente / revêtement anti-adhésif

	cm	↑ cm	ltr.	Farbe / colour	€
30517 <small>NEW</small>	12,5 x 12,5	6,5	0,5	black / silver	22,00
30503	19,0 x 19,0	9,0	1,5	black / silver	29,00
30504	25,0 x 25,0	12,0	3,8	black / silver	45,00
30518 <small>NEW</small>	30,0 x 30,0	14,0	8,0	black / silver	66,00



Dressingtopf / Flaschenkühler „FROSTFIRE“

dressing pot / bottle cooler
salsera / enfriador de botella
pot à sauce / rafraîchisseur



Antihafbeschichtung / non stick coating / antiadherente / revêtement anti-adhésif

	Ø cm	↑ cm	ltr.	Farbe / colour	€
36140	11,5 / 11	15	1,4	black / silver	18,60

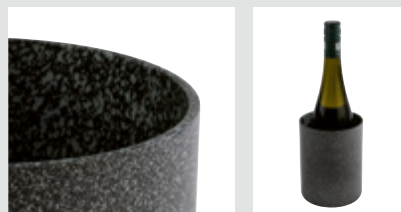

auch als Flaschenkühler verwendbar
also usable as a bottle cooler



Schale „FROSTFIRE“

bowl
cuenco
bol



Antihafbeschichtung / non stick coating / antiadherente / revêtement anti-adhésif

	Ø cm	↑ cm	ltr.	Farbe / colour	€
30017	26,5	7 / 12	1,9	beige / sand	42,00
30019	26,5	7 / 12	1,9	red	42,00
30018	26,5	7 / 12	1,9	green	42,00
30015	26,5	7 / 12	1,9	black / silver	42,00
30016	26,5	7 / 12	1,9	black	42,00



FROSTFIRE



Schale „FROSTFIRE“

bowl
cuenco
bol

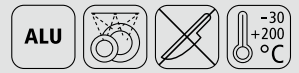

Antihafbeschichtung / non stick coating / antiadherente / revêtement anti-adhésif

	∅ cm	↑ cm	ltr.	Farbe / colour	€
30024	32,5	8 / 14	3	beige / sand	48,00
30014	32,5	8 / 14	3	red	48,00
30013	32,5	8 / 14	3	green	48,00
30010	32,5	8 / 14	3	black / silver	48,00
30011	32,5	8 / 14	3	black	48,00



Wärmelampe mit 2 Infrarotlampen

thermal bridge
puente térmico
pont thermique

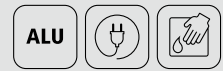

höhenverstellbar 58 - 77,5 cm, inklusive 2 Lampen, Kabellänge: 1,5 Meter

height adjustable from 58 to 77,5 cm, including 2 infrared lamps, cable length: 1,5 metres
regulable en altura de 58 a 77,5 cm, con 2 lámparas de infrarrojas, longitud del cable: 1,5 metros
réglable en hauteur de 58 à 77,5 cm, avec 2 lampes infrarouges, longueur du câble: 1,5 mètre

	cm	↑ cm	V	W	€
12265	50 x 35	58 - 77,5	230	2 x 250	145,00

Ersatzbirne für Wärmelampe

infrared lamp / bulb
lámpara infrarroja / bombilla
lampe infrarouge / ampoule

Fassung E27, Lichtfarbe: warmweiß

socket: E27, light colour: warm white
casquillo: E27, color de la luz: blanco cálido
douille: E27, couleur de lumière: blanc chaud

	W	fits to	€
12266	250	12265, 12267	11,00



Wärmelampe mit Infrarotlampe

thermal bridge
puente térmico
pont thermique

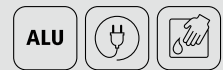

mit flexibel einstellbarem Arm, stabiler Standfuß, Kabellänge: 1,5 Meter

with flexibly adjustable arm, stable base, cable length: 1,5 metres
con brazo ajustable de forma flexible, base estable, longitud del cable: 1,5 metros
avec bras réglable de manière flexible, socle stable, longueur de câble : 1,5 mètre

	cm	↑ cm	V	W	€
12267	27 x 20,5	68	230	1 x 250	145,00

Ersatzbirne für Wärmelampe

infrared lamp / bulb
lámpara infrarroja / bombilla
lampe infrarouge / ampoule

Fassung E27, Lichtfarbe: warmweiß

socket: E27, light colour: warm white
casquillo: E27, color de la luz: blanco cálido
douille: E27, couleur de lumière: blanc chaud

	W	fits to	€
12266	250	12265, 12267	11,00

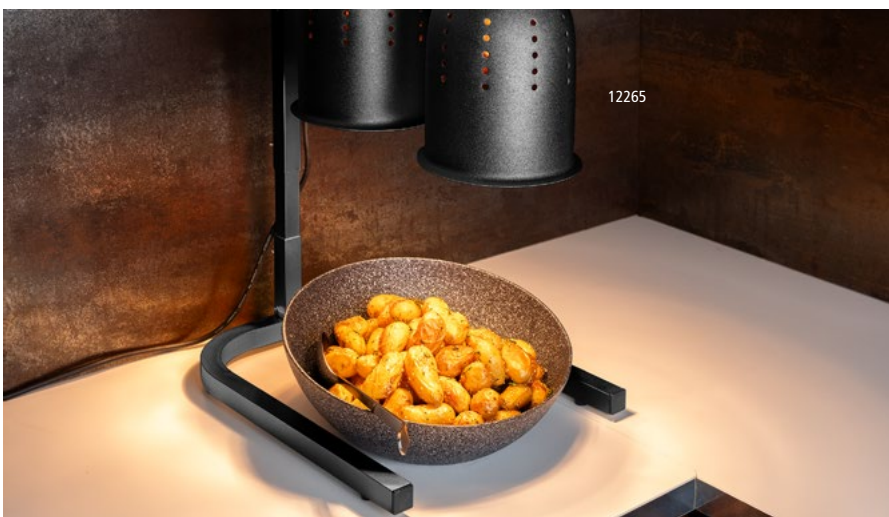

5 STARS



NEW



88340 2 ltr.



88341 2 ltr.



88342 2 ltr.

Brat- und Servierpfanne „5 STARS“
 frying and serving pan
 poêle à frire et à servir
 sartén para freír y servir



	∅ cm	↑ cm	ltr.	Farbe / colour	€
88340	29	5,5	2		52,00
88341	29	5,5	2		52,00
88342	29	5,5	2		52,00

NEW



88330 0,35 ltr.



88331 0,35 ltr.



88332 0,35 ltr.

Mini-Topf mit Deckel „5 STARS“

mini pot with lid
mini olla con tapa
mini casserole avec couvercle



	Ø cm	↑ cm	ltr.	Farbe / colour	€
88330	11	6,5 / 9	0,35		24,00
88331	11	6,5 / 9	0,35		24,00
88332	11	6,5 / 9	0,35		24,00



NEW



88333 0,45 ltr.



88334 0,45 ltr.



88335 0,45 ltr.

Mini-Topf mit Deckel „5 STARS“

mini pot with lid
mini olla con tapa
mini casserole avec couvercle



	Ø cm	↑ cm	ltr.	Farbe / colour	€
88333	14,5 x 11,5	6,5 / 9	0,45		26,00
88334	14,5 x 11,5	6,5 / 9	0,45		26,00
88335	14,5 x 11,5	6,5 / 9	0,45		26,00



5 STARS



Kochtopf mit Deckel „5 STARS“

cooking pot with lid
olla con tapa
marmite avec couvercle

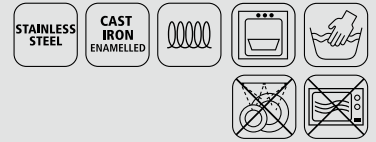

	Ø cm	↑ cm	ltr.	Farbe / colour	€
88302	25	11,5 / 17,5	4		69,00
88303	25	11,5 / 17,5	4		69,00
88313	25	11,5 / 17,5	4		69,00



inklusive Deckelhalter
including lid holder



Kochtopf mit Deckel „5 STARS“

cooking pot with lid
olla con tapa
marmite avec couvercle

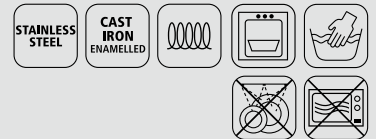

	Ø cm	↑ cm	ltr.	Farbe / colour	€
88306	28	13 / 20	6		79,00
88307	28	13 / 20	6		79,00
88315	28	13 / 20	6		79,00



inklusive Deckelhalter
including lid holder



Bräter mit Deckel „5 STARS“

roaster with lid
cacerola con tapa
cocotte avec couvercle

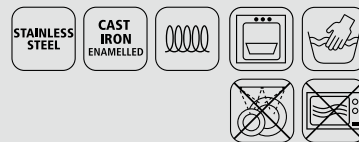

	Ø cm	↑ cm	ltr.	Farbe / colour	€
88300	25	7 / 13	2,5		63,00
88301	25	7 / 13	2,5		63,00
88312	25	7 / 13	2,5		63,00



inklusive Deckelhalter
including lid holder



Bräter mit Deckel „5 STARS“

roaster with lid
cacerola con tapa
cocotte avec couvercle

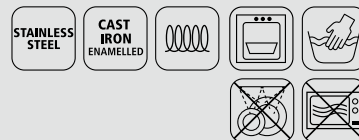

	Ø cm	↑ cm	ltr.	Farbe / colour	€
88304	28	7 / 13,5	3		74,00
88305	28	7 / 13,5	3		74,00
88314	28	7 / 13,5	3		74,00



inklusive Deckelhalter
including lid holder



Bräter mit Deckel „5 STARS“

roaster with lid
cacerola con tapa
cocotte avec couvercle

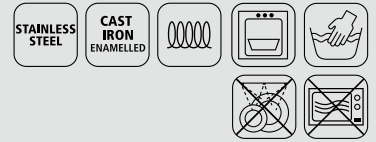

	cm	↑ cm	ltr.	Farbe / colour	€
88308	33 x 25	11 / 17,5	5		84,00
88309	33 x 25	11 / 17,5	5		84,00
88316	33 x 25	11 / 17,5	5		84,00



inklusive Deckelhalter
including lid holder



Deckelhalter, 2er Set

lid holder, 2 pcs.
soporte para tapa, set de 2
support de couvercle, set de 2



mit Antirutschbeschichtung, für alle Töpfe mit Deckel einsetzbar, hitzebeständig

with non-slip coating, suitable for all pots with lids, heat-resistant

con revestimiento antideslizante, apto para todas las ollas con tapa, resistente al calor

avec revêtement antidérapant, adapté à toutes les casseroles avec couvercle, résistant à la chaleur

	cm	↑ cm	Farbe / colour	pcs.	€ / set
88320	10,5 x 8,5	3,5		2	10,00



Auflaufform „5 STARS“

casserole dish
fuente para gratinar
plat à four



	cm	↑ cm	ltr.	Farbe / colour	€
88310	33 x 24	6,5	3,5		58,00
88311	33 x 24	6,5	3,5		58,00
88317	33 x 24	6,5	3,5		58,00



88310 3,5 ltr.



88311 3,5 ltr.



88317 3,5 ltr.



ORBIT



12344



12342



12343



12330



12335

Chafing Dish, 4-teiliges Set „ORBIT“

chafing dish set, 4 pcs.
chafing dish, set de 4
chafing dish, set de 4



- 1 Topf (8 Liter), 1 Speisenbehälter (4 Liter), 1 Deckel mit Sichtfenster und 1 Deckelbremse
- 1 pot (8 litres), 1 foodpan (4 litres), 1 lid with glass insert and 1 automatic lid brake
- 1 olla (8 litros), 1 cubeta (4 litros), 1 tapa con ventanilla y 1 sistema de freno en la tapa
- 1 casserole (8 litres), 1 bac (4 litres), 1 couvercle avec fenêtre et 1 frein de couvercle

	Ø cm	↑ cm	ltr.	Farbe / colour	€
12344 NEW	30,5	17,5	4	sand	314,00
12342	30,5	17,5	4	vintage-look	314,00
12343	30,5	17,5	4	gold	314,00
12330	30,5	17,5	4	stainless steel	260,00
12335	30,5	17,5	4	copper	314,00

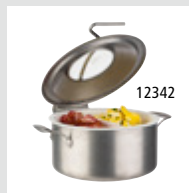

12342

abnehmbarer Deckel
removable lid

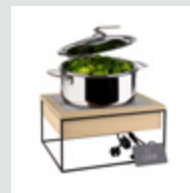

induktionsgeeignet
suitable for induction

Ersatz-Speisenbehälter zu Chafing Dish / replacement foodpan for chafing dish / cubeta interior de repuesto para chafing dish / bac intérieur de remplacement pour le chafing dish

	Ø cm	↑ cm	ltr.	fits to	€
12329	30,5	8	4	12330, 12335, 12336, 12337, 12338, 12339, 12342, 12343, 12344	30,00



Ø 33 cm

8 ltr. Topf
8 ltr. pot



12329

Ø 30,5 cm

4 ltr. Speisenbehälter
4 ltr. foodpan

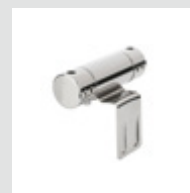

Deckelbremse
automatic lid break

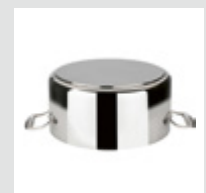

Sandwich- / Kapsel-
boden / sandwich base

Chafing Dish, 4-teiliges Set „ORBIT“

chafing dish set, 4 pcs.
chafing dish, set de 4
chafing dish, set de 4



- 1 Topf (8 Liter), 1 Speisenbehälter (4 Liter), 1 Deckel mit Sichtfenster und 1 Deckelbremse
- 1 pot (8 litres), 1 foodpan (4 litres), 1 lid with glass insert and 1 automatic lid brake
- 1 olla (8 litros), 1 cubeta (4 litros), 1 tapa con ventanilla y 1 sistema de freno en la tapa
- 1 casserole (8 litres), 1 bac (4 litres), 1 couvercle avec fenêtre et 1 frein de couvercle



12336



12337



12338



12339

	Ø cm	↑ cm	ltr.	Farbe / colour	€
12336	30,5	17,5	4	yellow	314,00
12337	30,5	17,5	4	red	314,00
12338	30,5	17,5	4	black	314,00
12339	30,5	17,5	4	green	314,00

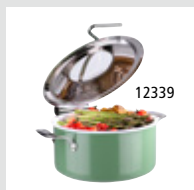

12339



abnehmbarer Deckel
removable lid

induktionsgeeignet
suitable for induction

Ersatz-Speisenbehälter zu Chafing Dish / replacement foodpan for chafing dish / cubeta interior de repuesto para chafing dish / bac intérieur de remplacement pour le chafing dish

	Ø cm	↑ cm	ltr.	fits to	€
12329	30,5	8	4	12330, 12335, 12336, 12337, 12338, 12339, 12342, 12343, 12344	30,00



Ø 33 cm

8 ltr. Topf
8 ltr. pot



12329

Ø 30,5 cm

4 ltr. Speisenbehälter
4 ltr. foodpan



Deckelbremse
automatic lid break

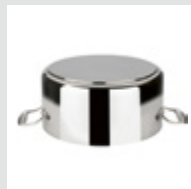

Sandwich- / Kapsel-
boden / sandwich base



82212 2 x 1,4 ltr.



82211 3 ltr.

Porzellaneinsatz „ORBIT“

porcelain insert
bandeja de porcelana
bac en porcelaine



	Ø cm	↑ cm	ltr.	fits to	€
82212	29,5	9	2,8	12330, 12335, 12336, 12337, 12338, 12339, 12342, 12343, 12344	62,00
82211	29,5	9	3,0	12330, 12335, 12336, 12337, 12338, 12339, 12342, 12343, 12344	56,00

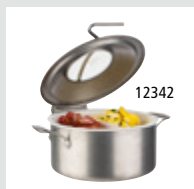

12342



82212

passend zur Serie „ORBIT“
suitable for the „ORBIT“ series



NEW

TWIRL



40360
GN 1/1 – 6,5 cm



40361
GN 1/2 – 6,5 cm



40362
GN 1/3 – 6,5 cm



40363
GN 1/4 – 6,5 cm



40364
GN 1/6 – 6,5 cm



40365
GN 2/4 – 6,5 cm

GN Korb „TWIRL“

GN basket
GN cesta
GN corbeille



stabile Ausführung mit pulverbeschichtetem Edeldraht zur Stabilisierung
 very solid with powder-coated stainless steel wire to stabilize the basket
 muy resistente, con refuerzo de acero inoxidable para mayor estabilidad
 très résistant avec renfort en acier inoxydable pour plus de stabilité

	cm	↑ cm	GN	€
40360	53,0 x 32,5	6,5	1/1	26,00
40361	32,5 x 26,5	6,5	1/2	15,80
40362	32,5 x 17,6	6,5	1/3	12,60
40363	26,5 x 16,2	6,5	1/4	9,60
40364	17,6 x 16,2	6,5	1/6	6,50
40365	53,0 x 16,2	6,5	2/4	16,00

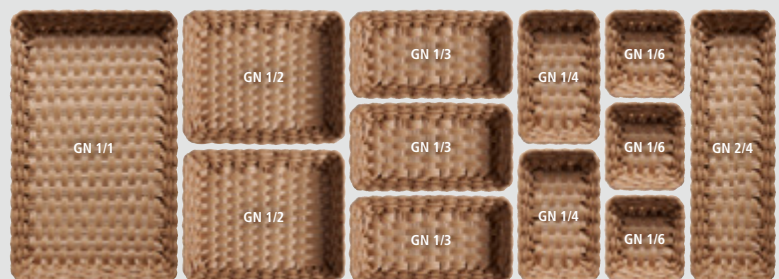

GN Korb „TWIRL“

GN basket

GN cesta

GN corbeille



stabile Ausführung mit pulverbeschichtetem Edeldraht zur Stabilisierung

very solid with powder-coated stainless steel wire to stabilize the basket

muy resistente, con refuerzo de acero inoxidable para mayor estabilidad

très résistant avec renfort en acier inoxydable pour plus de stabilité



40370
GN 1/1 – 10 cm



40371
GN 1/2 – 10 cm



40372
GN 1/3 – 10 cm



40373
GN 1/4 – 10 cm



40374
GN 1/6 – 10 cm



40375
GN 2/4 – 10 cm

	cm	↑ cm	GN	€
40370	53,0 x 32,5	10	1/1	31,00
40371	32,5 x 26,5	10	1/2	18,40
40372	32,5 x 17,6	10	1/3	14,20
40373	26,5 x 16,2	10	1/4	11,00
40374	17,6 x 16,2	10	1/6	9,40
40375	53,0 x 16,2	10	2/4	18,60

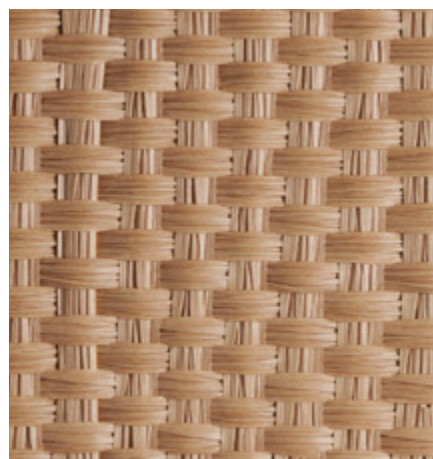
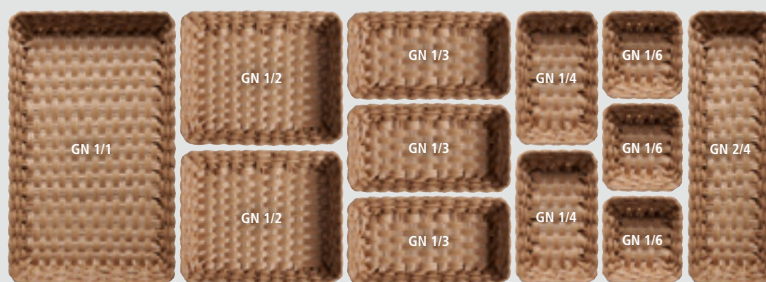



URBAN

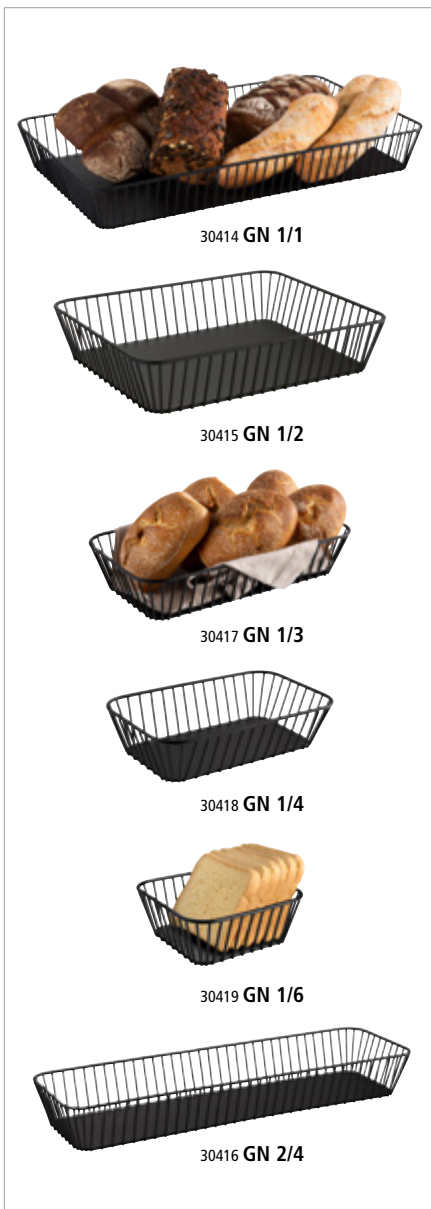

GN Korb „URBAN“

GN basket
GN cesta
GN corbeille



	cm	↑ cm	GN	€
30414	53,0 x 32,5	7	1/1	35,00
30415	32,5 x 26,5	7	1/2	26,00
30417	32,5 x 17,6	7	1/3	19,00
30418	26,5 x 16,2	7	1/4	16,00
30419 <small>NEW</small>	17,6 x 16,2	7	1/6	15,00
30416	53,0 x 16,2	7	2/4	26,00

	GN 1/2	GN 1/3	GN 1/4	GN 1/6	
GN 1/1		GN 1/3		GN 1/6	GN 2/4
	GN 1/2	GN 1/3	GN 1/4	GN 1/6	



Korb „URBAN“

basket
cesta
corbeille



	∅ cm	↑ cm	€
30410	17	6,5	14,40
30411	20	8,0	18,00

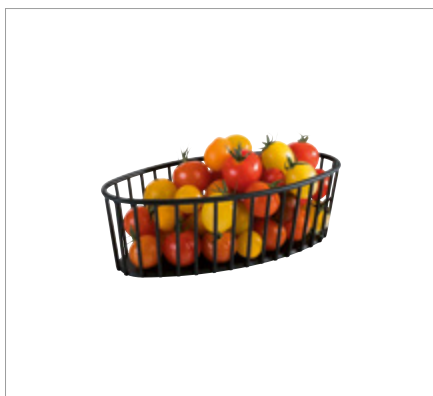

Korb „URBAN“

basket
cesta
corbeille



	cm	↑ cm	€
30412	21 x 10	6,5	12,80



Korb „URBAN“

basket
cesta
corbeille



	cm	↑ cm	€
30337	29 x 16	6,5	19,00



Brot- und Obstkorb „URBAN“

basket for bread or fruits
cesta para pan o fruta
corbeille à pain ou à fruits



	∅ cm	↑ cm	€
30211	22,5	28	26,00

CRAFT

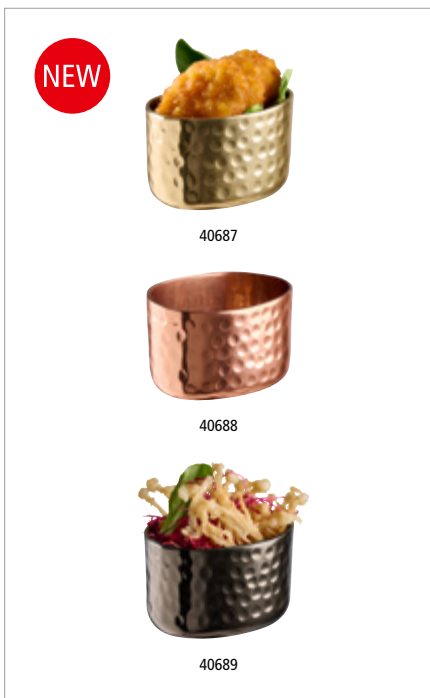

Schale „CRAFT“

bowl
cuenco
bol

gehämmerte Oberfläche
hammered surface
superficie martillada
surface martelée



	cm	↑ cm	ltr.	Farbe / colour	€
40687	8,5 x 6,5	5,5	0,15	gold-look	9,00
40688	8,5 x 6,5	5,5	0,15	copper-look	9,00
40689	8,5 x 6,5	5,5	0,15	gunmetal-look	9,00



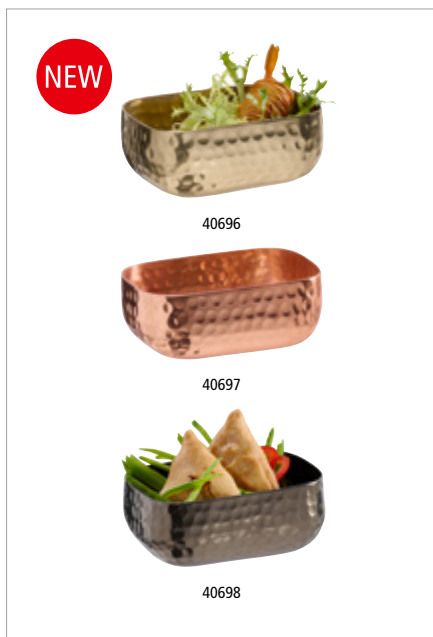

Schale „CRAFT“

bowl
cuenco
bol

gehämmerte Oberfläche

hammered surface
superficie martillada
surface martelée



	cm	↑ cm	ltr.	Farbe / colour	€
40696	12,0 x 9,5	5,0	0,35	gold-look	12,00
40697	12,0 x 9,5	5,0	0,35	copper-look	12,00
40698	12,0 x 9,5	5,0	0,35	gunmetal-look	12,00



Schale „CRAFT“

bowl
cuenco
bol

gehämmerte Oberfläche

hammered surface
superficie martillada
surface martelée



	cm	↑ cm	ltr.	Farbe / colour	€
40690	15,5 x 12	5,5	0,7	gold-look	14,00
40691	15,5 x 12	5,5	0,7	copper-look	14,00
40692	15,5 x 12	5,5	0,7	gunmetal-look	14,00



Schale „CRAFT“

bowl
cuenco
bol

gehämmerte Oberfläche

hammered surface
superficie martillada
surface martelée



	cm	↑ cm	ltr.	Farbe / colour	€
40693	23 x 15,5	6,0	1,4	gold-look	21,00
40694	23 x 15,5	6,0	1,4	copper-look	21,00
40695	23 x 15,5	6,0	1,4	gunmetal-look	21,00

BEVERAGE DISPENSERS



Getränkespender beverage dispenser dispensador de bebidas distributeur de boissons



Behälter aus Glas, Zapfhahn aus Edelstahl, Deckel aus Edelstahl
glass container, stainless steel tap, lid in stainless steel
recipiente de vidrio, grifo de acero inoxidable, tapa de acero inoxidable
récipient en verre, robinet en acier inox, couvercle en acier inox

	Ø cm	↑ cm	ltr.	€
10818	16	25,0	3,8	49,00
10819 <small>NEW</small>	20	23,0	5,0	59,00
10855	20	30,5	7,0	76,00



Eiswasserröhre separat erhältlich
ice cube cooling tube available separately



Untersetzer

saucer
plattillo
sous-assiette



Untersetzer für Getränkespender, schützt den Untergrund vor Wasserrändern

saucer for beverage dispensers, protects the surface from water marks

plattillo para dispensadores de bebidas, protege la superficie las marcas de agua contra

sous-assiette pour distributeurs de boissons, protège le support contre les traces d'eau

	Ø cm	↑ cm	fits to	€
85233	16	1	10818	7,00
85232	19	1	10855, 10819	8,40



Tropfenschale, 2-teilig

drip tray, 2 pcs.
aros anti-goteo, set de 2
anneaux coupe-gouttes, set de 2

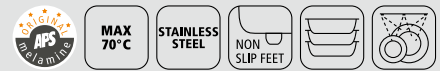

	Ø cm	↑ cm	Farbe / colour	€
10851	9,5	1,5	white	8,00
10841	9,5	1,5	black	8,00



Eiswasserröhre

ice cube cooling tube
tubo enfriador para cubitos
tube pour glaçons



	Ø cm	↑ cm	fits to beverage dispensers	€
10849	11	23	10400, 10403, 10450, 10451, 10452, 10460, 10818, 10855, 14015, 14016, 14025, 14115, 14125	9,40



NEW AUREO



Wein- / Sektkühler „AUREO“

wine / champagne bowl
 cubitera para vino / cava
 seau à vin / champagne



hochwertige äußere Facettierung, Rand & Bodenring in Gunmetal-Look

high-quality outer bevelling, rim & base ring in gunmetal look

facetas exteriores de alta calidad, aro y anillo de base en gunmetal

facettage extérieure de haute qualité, bord & anneau de fond en look gunmetal

	Ø cm	↑ cm	ltr.	€
36160	28	25	10	44,00

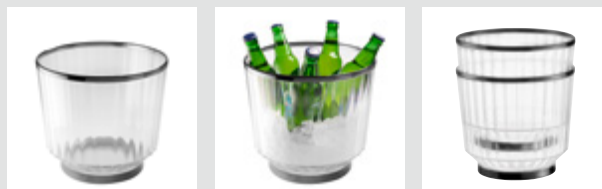



10725
0,5 ltr.

10726
1,0 ltr.

10727
1,5 ltr.

Glaskaraffe „LINES“

glass carafe
jarra de vidrio
carafe en verre

GLASS

CORK

ideal für Cerealien, Säfte oder Milch, Deckel aus Kork

ideal for cereals, juices or milk, cork lid

ideal para cereales, zumos o leche, tapa de corcho

idéal pour les céréales, les jus de fruits ou le lait, couvercle en liège

	Ø cm	↑ cm	ltr.	€
10725	9	19,5	0,5	15,00
10726	9	27,5	1,0	21,00
10727	9	35,0	1,5	22,00



0,75 ltr.

Glaskaraffe „LINES“

glass carafe
jarra de vidrio
carafe en verre

GLASS

CORK

ideal für Cerealien, Säfte oder Milch, Deckel aus Kork

ideal for cereals, juices or milk, cork lid

ideal para cereales, zumos o leche, tapa de corcho

idéal pour les céréales, les jus de fruits ou le lait, couvercle en liège

	Ø cm	↑ cm	ltr.	€
10738	8	28	0,75	20,00



NEW



2,0 ltr.

Soft- & Wasserkanne

juice & water pitcher
jarra de zumo & agua
pichet à eau & jus de fruit



mit Edelstahldeckel und integriertem Sieb – ideal für Wasser, Saft oder Infused-Drinks
with stainless steel lid and integrated strainer – ideal for water, juice, or infused drinks
con tapa de acero inoxidable y colador integrado – ideal para agua, zumo o bebidas infusionadas
avec couvercle en acier inox et filtre intégré – idéal pour l'eau, les jus ou les boissons infusées

	Ø cm	↑ cm	ltr.	€
10728	13	23	2	21,00



2-farbig / 2 colours

NEW FRIGIO

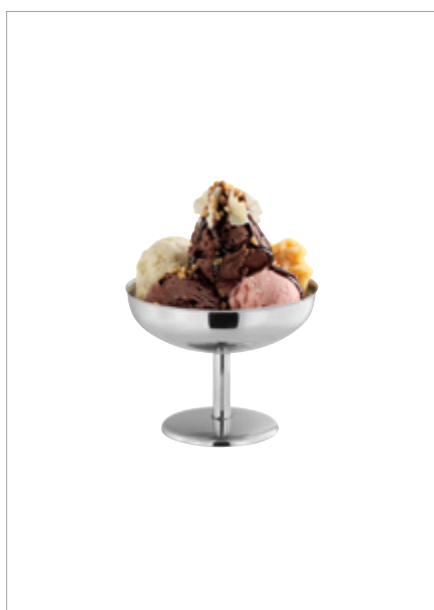

Eisbecher, 2er Set „FRIGIO“

ice cream cup, set of 2
copa de helado, set de 2
sundae, set de 2



ideal als Eisbecher, Dessertschale oder für das Flying Buffet

ideal as an ice cream cup, dessert bowl or for the flying buffet

ideal como copa de helado, cuenco de postre o para el flying buffet

idéal comme coupe à glace, coupe à dessert ou pour le flying buffet

	Ø cm	↑ cm	ml	pcs.	€/ set
40910	10,5	8,5	180	2	16,00

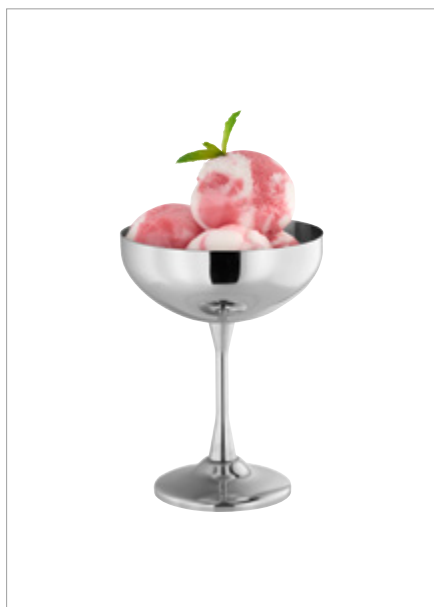
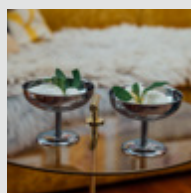
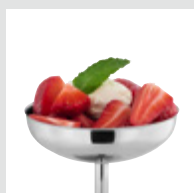

Eisbecher, 2er Set „FRIGIO“

ice cream cup, set of 2
copa de helado, set de 2
sundae, set de 2



ideal als Eisbecher, Dessertschale oder für das Flying Buffet

ideal as an ice cream cup, dessert bowl or for the flying buffet

ideal como copa de helado, cuenco de postre o para el flying buffet

idéal comme coupe à glace, coupe à dessert ou pour le flying buffet

	Ø cm	↑ cm	ml	pcs.	€/ set
40911	10,5	14,0	260	2	18,00

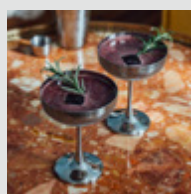
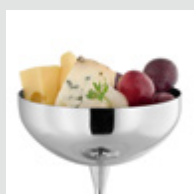

PERFECTION



UNZERBRECHLICH
UNBREAKABLE



Martiniglas „PERFECTION“

Martini glass
copa de Martini
verre à Martini



	Ø cm	↑ cm	ml	VE / unit	€ / pc.
10545	12	17	200	12	6,80



Cocktailglas „PERFECTION“

cocktail glass
copa de cóctel
verre à cocktail



	Ø cm	↑ cm	ml	VE / unit	€ / pc.
10546	7,5	20,5	400	12	8,00



Sektglas „PERFECTION“

champagne glass
copa de champán
flûte à champagne



	Ø cm	↑ cm	ml	VE / unit	€ / pc.
10540	5	23	190	12	6,40



Weißweinglas „PERFECTION“

white wine glass
copa de vino blanco
verre à vin blanc



	Ø cm	↑ cm	ml	VE / unit	€ / pc.
10541	8	21,5	320	12	7,60



Rotweinglas „PERFECTION“

red wine glass
copa de vino tinto
verre à vin rouge



	Ø cm	↑ cm	ml	VE / unit	€ / pc.
10542	10,5	21	600	12	8,60



Trinkglas „PERFECTION“

drinking glass
vaso para beber
verre à boire



	Ø cm	↑ cm	ml	VE / unit	€ / pc.
10543	8	11,5	330	12	6,60



Trinkglas „PERFECTION“

drinking glass
vaso para beber
verre à boire



	Ø cm	↑ cm	ml	VE / unit	€ / pc.
10544	8	15	470	12	7,40

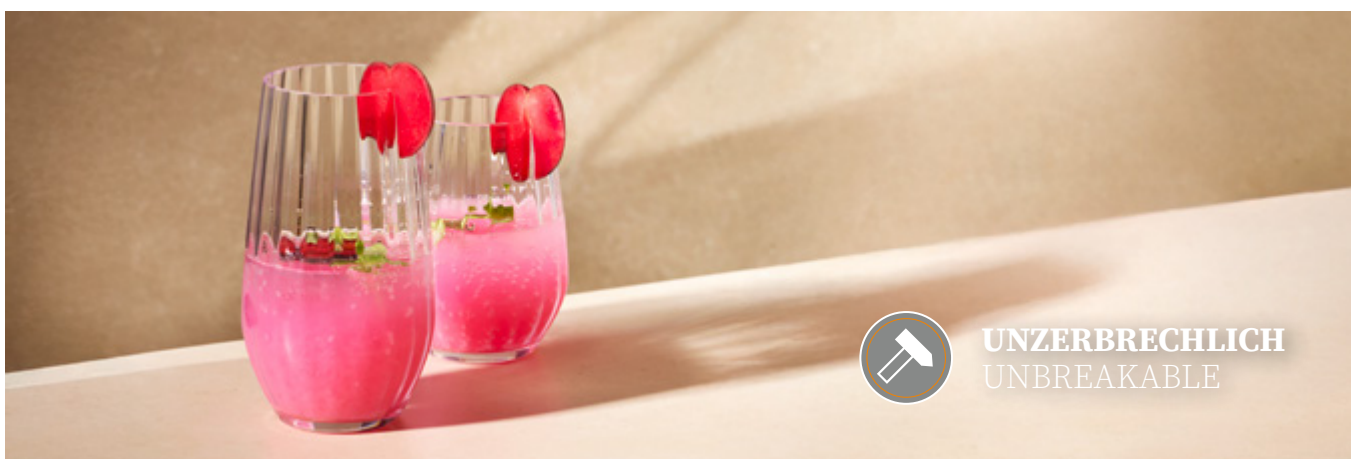

SNUG



Espressotasse „SNUG“ espresso cup taza de espresso tasse à espresso



	Ø cm	↑ cm	ml	Farbe / colour	VE / unit	€ / pc.
16000	6	5,5	80		6	2,90
16001	6	5,5	80		6	2,90
16002	6	5,5	80		6	2,90



Espressountertasse „SNUG“ espresso saucer plattilo de espresso soucoupe à espresso



	Ø cm	↑ cm	Farbe / colour	VE / unit	€ / pc.
16009	11,5	2		6	2,80
16010	11,5	2		6	2,80
16011	11,5	2		6	2,80



Kaffeetasse „SNUG“

coffee cup
taza de café
tasse à café



	Ø cm	↑ cm	ml	Farbe / colour	VE / unit	€ / pc.
16003	9,5	6	200		6	4,30
16004	9,5	6	200		6	4,30
16005	9,5	6	200		6	4,30



Kaffeuntertasse „SNUG“

coffee saucer
plattillo de café
soucoupe à café



	Ø cm	↑ cm		Farbe / colour	VE / unit	€ / pc.
16012	14,5	2,5			6	3,40
16013	14,5	2,5			6	3,40
16014	14,5	2,5			6	3,40



Cappuccinotasse „SNUG“

cappuccino cup
taza de cappuccino
tasse à cappuccino



	Ø cm	↑ cm	ml	Farbe / colour	VE / unit	€ / pc.
16006	10,5	6,5	300		6	5,90
16007	10,5	6,5	300		6	5,90
16008	10,5	6,5	300		6	5,90



Cappuccinounterstasse „SNUG“

cappuccino saucer
plattillo de cappuccino
soucoupe cappuccino



	Ø cm	↑ cm		Farbe / colour	VE / unit	€ / pc.
16015	15,5	2,5			6	3,80
16016	15,5	2,5			6	3,80
16017	15,5	2,5			6	3,80

NEW



16018



16019



16020

Kaffeebecher „SNUG“

coffee mug
taza de café
tasse à café



	Ø cm	↑ cm	ml	Farbe / colour	VE / unit	€ / pc.
16018	8,5	10	330		6	6,00
16019	8,5	10	330		6	6,00
16020	8,5	10	330		6	6,00

NEW



16024



16025



16026

Teller „SNUG“

plate
plato
assiette





	Ø cm	↑ cm	Farbe / colour	VE / unit	€ / pc.
16024	20,5	2		6	8,40
16025	20,5	2		6	8,40
16026	20,5	2		6	8,40

NEW

Schale „SNUG“

bowl
cuenco
bol



	Ø cm	↑ cm	ml	Farbe / colour	VE / unit	€ / pc.
16021	12	6	250		6	6,40
16022	12	6	250		6	6,40
16023	12	6	250		6	6,40



16021



16022



16023



VELMA



Tischset „VELMA“
placemat
mantelín
set de table



	cm	Farbe / colour	€
60591	45 x 33	hellbraun / light brown	7,00



rutschhemmende Unterseite
non-slip bottom



Tischset „VELMA“
placemat
mantelín
set de table



	cm	Farbe / colour	€
60590	45 x 33	hellblau transparent / light blue transparent	7,00

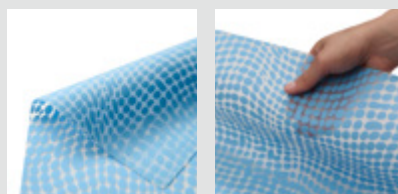

transparent, rutschhemmende Unterseite
transparent, non-slip bottom

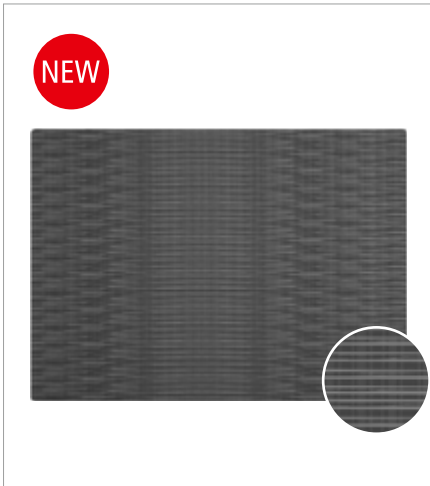

Tischset „VELMA“
placemat
mantelín
set de table

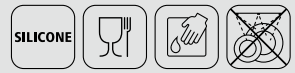

	cm	Farbe / colour	€
60589	45 x 33	grau / grey	7,00

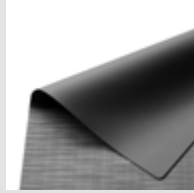

rutschhemmende Unterseite
non-slip bottom



Tischset „VELMA“
placemat
mantelín
set de table



	cm	Farbe / colour	€
60588	45 x 33	hellbraun / light brown	7,00



rutschhemmende Unterseite
non-slip bottom



Tischset „VELMA“
placemat
mantelín
set de table



	cm	Farbe / colour	€
60587	45 x 33	hellblau transparent / light blue transparent	7,00

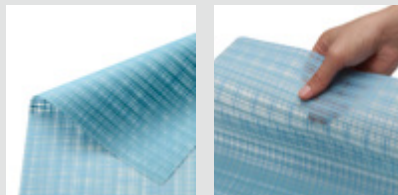

transparent, rutschhemmende Unterseite
transparent, non-slip bottom

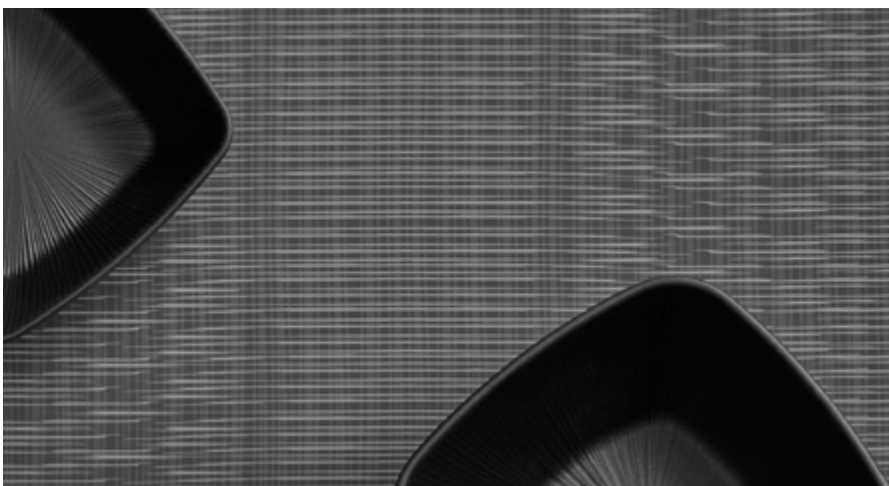

PLACEMATS



Tischset „VELMA“
 placemat
 mantelín
 set de table

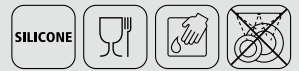

	cm	Farbe / colour	€
60580	45 x 33	beige / beige	7,20



rutschhemmende Unterseite
 non-slip bottom



Tischset „VELMA“
 placemat
 mantelín
 set de table



	cm	Farbe / colour	€
60581	45 x 33	grün / green	7,20



rutschhemmende Unterseite
 non-slip bottom

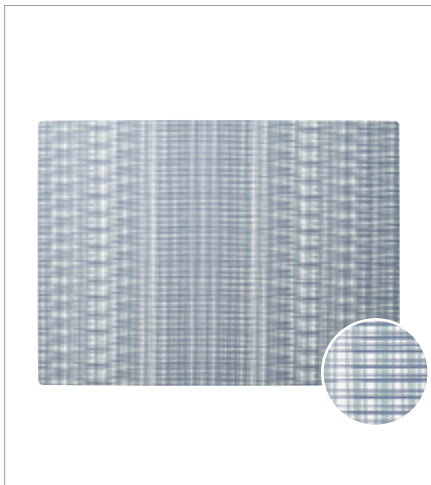

Tischset „VELMA“
 placemat
 mantelín
 set de table



	cm	Farbe / colour	€
60582	45 x 33	blau / blue	7,20



rutschhemmende Unterseite
 non-slip bottom

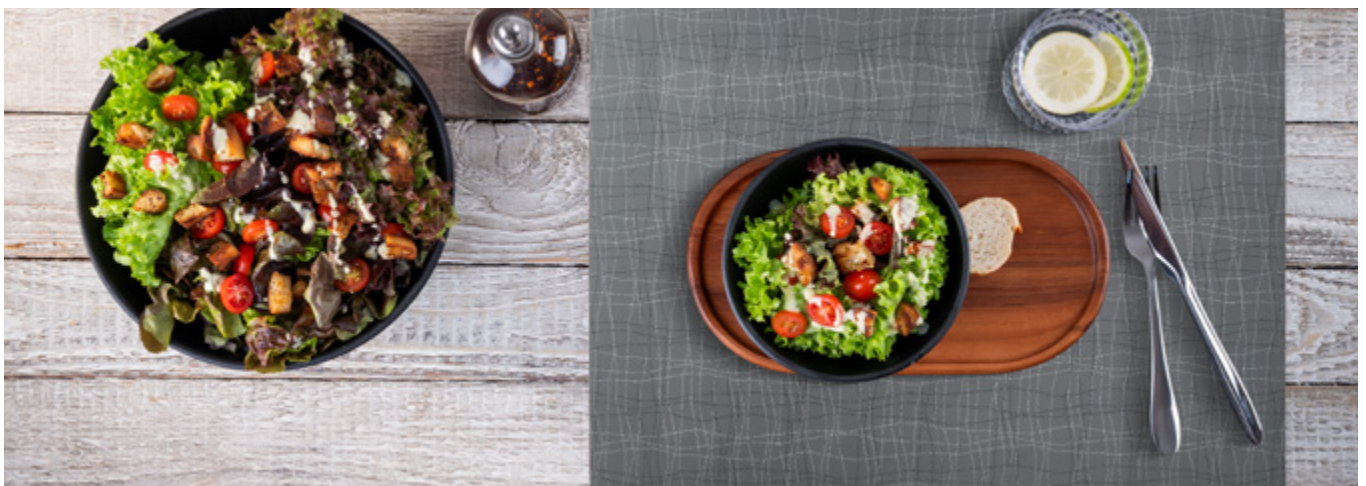



Tischset „VELMA“
placemat
mantelín
set de table

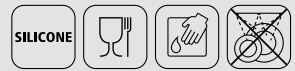

	cm	Farbe / colour	€
60584	45 x 33	beige / beige	7,20



rutschhemmende Unterseite
non-slip bottom

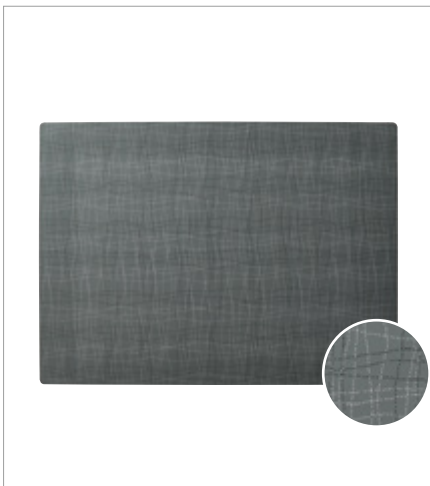

Tischset „VELMA“
placemat
mantelín
set de table



	cm	Farbe / colour	€
60583	45 x 33	anthrazit / anthracite	7,20



rutschhemmende Unterseite
non-slip bottom



Tischset „VELMA“
placemat
mantelín
set de table



	cm	Farbe / colour	€
60585	45 x 33	grün / green	7,20



rutschhemmende Unterseite
non-slip bottom



Tischset „VELMA“
placemat
mantelín
set de table



	cm	Farbe / colour	€
60586	45 x 33	dunkelblau / dark blue	7,20



rutschhemmende Unterseite
non-slip bottom

NEW SOHO



✓
inklusive Ladestation
charging station included

✓
USB Ladekabel
USB charging cable

✓
Fernbedienung inkl. Batterie
remote control incl. battery

✓
möbelschonende Unterseite
furniture-friendly underside



17120
glossy chrome

17121
glossy black

17122
glossy cashmere

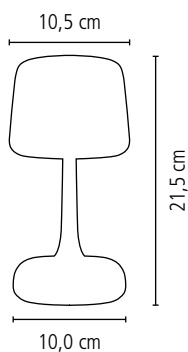

Tischleuchte
table lamp
lámpara de mesa
lampe de table



inklusive Ladestation, USB Ladekabel (ohne Netzteil), Fernbedienung inklusive Batterie
charging station included, USB charging cable (without mains adapter), remote control including battery
con estación de carga, cable de carga USB (sin adaptador de red), mando a distancia inclusivo pila
avec station de charge, câble de charge USB (sans bloc d'alimentation), télécommande avec pile

	cm	↑ cm	Farbe / colour	€
17120	10,5 x 10,5	21,5	glossy chrome	84,00
17121	10,5 x 10,5	21,5	glossy black	78,00
17122	10,5 x 10,5	21,5	glossy cashmere	78,00



NEW CALA



Teller „CALA“

plate
plato
assiette



	cm	↑ cm	€
85470	19,0 x 14,5	2,5	8,80
85471	27,0 x 21,0	2,5	14,00
85472	33,5 x 26,0	2,5	21,00



Teller „CALA“

plate
plato
assiette



	cm	↑ cm	€
85473	34 x 15,0	2,5	18,00

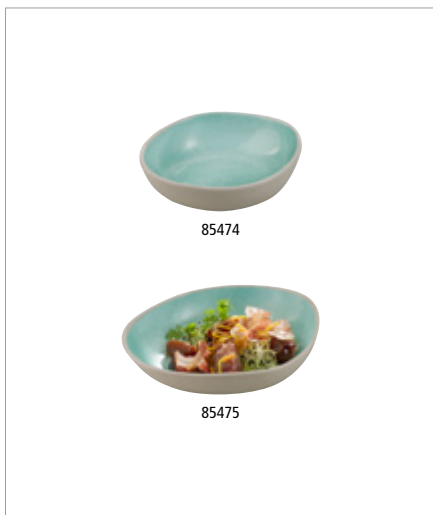

Schale „CALA“

bowl
cuenco
bol



	cm	↑ cm	ltr.	€
85474	15 x 13,5	4,5	0,25	8,80
85475	20,5 x 18,0	4,5	0,50	13,00

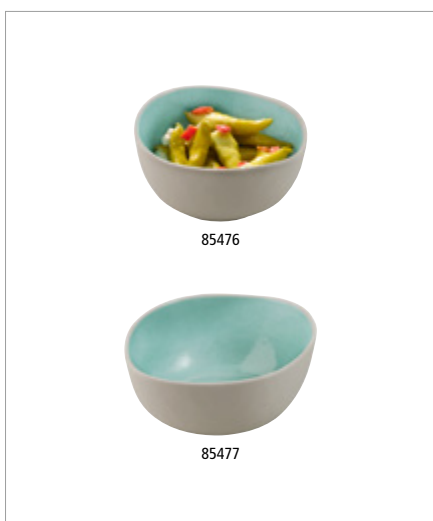

Schale „CALA“

bowl
cuenco
bol



	cm	↑ cm	ltr.	€
85476	16,0 x 14,5	7,0	0,7	10,00
85477	20,0 x 18,5	8,5	1,2	15,00





ARUMI



85600 GN 1/1

85601 GN 1/2

85602 GN 2/4

GN Tablett „ARUMI“

GN tray
GN bandeja
GN plateau



	cm	↑ cm	GN	€
85600	53,0 x 32,5	3	1/1	40,00
85601	32,5 x 26,5	3	1/2	21,00
85602	53,0 x 16,2	3	2/4	21,00

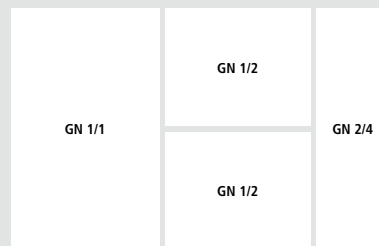

Teller „ARUMI“

plate
plato
assiette



	Ø cm	↑ cm	litr.	€
85605	22,5	4,5	0,8	12,80

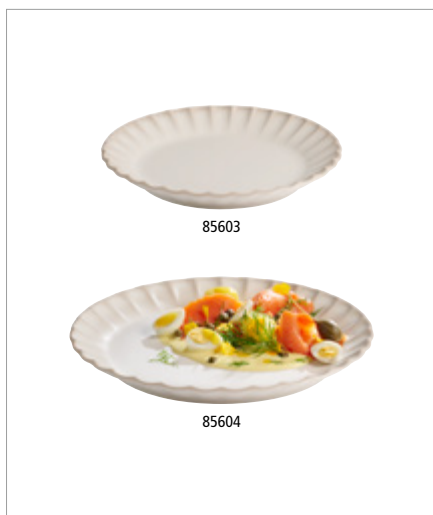

Teller „ARUMI“

plate
plato
assiette



	Ø cm	↑ cm	€
85603	21	3	9,00
85604	26	3	11,00



Schale „ARUMI“

bowl
cuenco
bol



	Ø cm	↑ cm	ltr.	€
85606	16	6	0,5	8,80
85607	19	8	1,0	14,00



Schale „ARUMI“

bowl
cuenco
bol



	cm	↑ cm	ltr.	€
85608	19 x 19	8	1,1	16,00
85609	25 x 25	11	2,8	26,00



NEW FLORYN



GN Tablett „FLORYN“

GN tray
GN bandeja
GN plateau



	cm	↑ cm	GN	€
85440	53,0 x 32,5	2,5	1/1	46,00
85441	32,5 x 26,5	2,5	1/2	22,00
85442	53,0 x 16,2	2,5	2/4	22,00

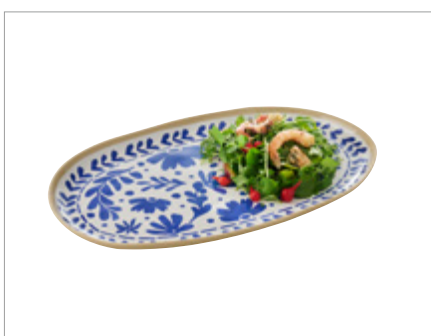
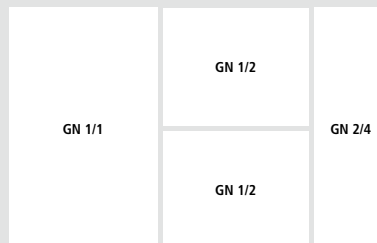

Tablett „FLORYN“

tray
bandeja
plateau



	cm	↑ cm	€
85446	40,5 x 24,5	2,5	23,00

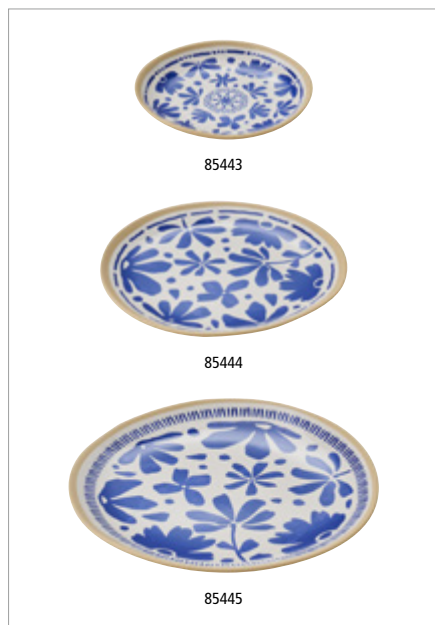

Teller „FLORYN“

plate
plato
assiette



	Ø cm	↑ cm	€
85443	15,5	2	7,00
85444	21,5	2	10,00
85445	27,0	2	15,00

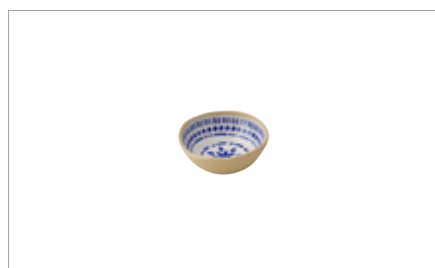

Schale „FLORYN“

bowl
cuenco
bol



	Ø cm	↑ cm	ltr.	€
85447	8	3	0,05	3,00

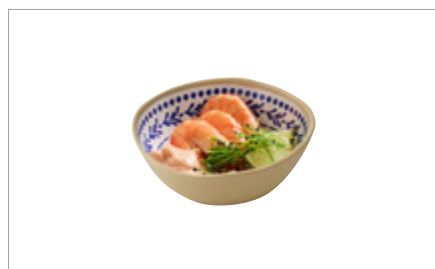

Schale „FLORYN“

bowl
cuenco
bol



	Ø cm	↑ cm	ltr.	€
85448	16	6,5	0,5	8,00



Schale „FLORYN“

bowl
cuenco
bol



	Ø cm	↑ cm	ltr.	€
85449	20	9	1,3	15,00



Schale „FLORYN“

bowl
cuenco
bol



	Ø cm	↑ cm	ltr.	€
85450	19	5	0,45	13,00
85451	33	6	2,40	24,00

FOOTMARK



NEW



85325 GN 1/1

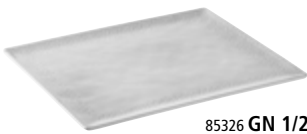

85326 GN 1/2



85327 GN 1/3



85328 GN 2/4

GN Tablett „FOOTMARK“

GN tray
GN bandeja
GN plateau



	cm	↑ cm	GN	€
85325	53,0 x 32,5	1,5	1/1	48,00
85326	32,5 x 26,5	1,5	1/2	22,00
85327	32,5 x 17,6	1,5	1/3	17,00
85328	53,0 x 16,2	1,5	2/4	22,00





Teller „FOOTMARK“

plate
plato
assiette



	Ø cm	↑ cm	€
85323	21,0	2,0	9,60
85324	26,5	2,5	12,80



Teller, tief „FOOTMARK“

plate, deep
plato, hondo
assiette, creuse



	Ø cm	↑ cm	ltr.	€
85322	24	4,0	0,8	13,00

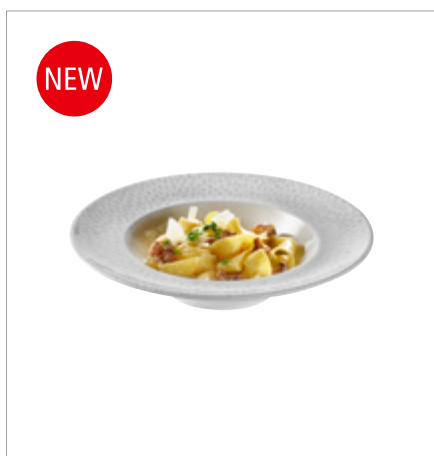

Teller „FOOTMARK“

plate
plato
assiette



	Ø cm	↑ cm	ltr.	€
85329	26,5	5,5	0,5	15,00



Schale „FOOTMARK“

bowl
cuenco
bol



	Ø cm	↑ cm	ltr.	€
85320	13	5,5	0,25	6,90
85321	18	5,5	0,6	10,00
85319 NEW	24	9,0	2,0	23,00

NERO



GN Tablett „NERO“

GN tray
GN bandeja
GN plateau



	cm	↑ cm	GN	€
85400	53,0 x 32,5	2,5	1/1	37,50
85401	32,5 x 26,5	2,5	1/2	20,00
85420 NEW	32,5 x 17,6	2,5	1/3	16,00
85421 NEW	26,5 x 16,2	2,5	1/4	13,00
85402	53,0 x 16,2	2,5	2/4	21,00

GN 1/1	GN 1/2	GN 1/3	GN 2/4	GN 1/4
	GN 1/2	GN 1/3		GN 1/4



Tablett „NERO“

tray
bandeja
plateau
mit 2 integrierten Dipschälchen
with 2 integrated dip bowls
con 2 cuencos para dip integrados
avec 2 ramequins intégrés



	cm	↑ cm	ltr.	€
85426	41 x 15	2,5	2 x 0,03	18,80

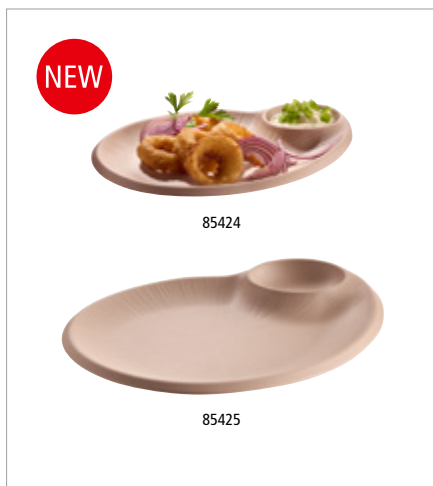

Teller „NERO“

plate
plato
assiette

mit integriertem Dipschälchen

with integrated dip bowl

con cuenco para dip integrado

avec ramequin intégré



85424

85425

	cm	↑ cm	ltr.	€
85424	24 x 20	2,5	0,04	9,40
85425	30 x 25	2,5	0,06	12,40



Teller „NERO“

plate
plato
assiette



85422

85403

85404

85405

85423

	Ø cm	↑ cm	€
85422 NEW	15	3,0	6,00
85403 NEW	21	3,0	8,20
85404	26	3,0	9,20
85405	33	3,5	14,20
85423 NEW	42	3,5	26,00



Teller „NERO“

plate
plato
assiette



	Ø cm	↑ cm	ltr.	€
85406	29	6	0,3	16,80

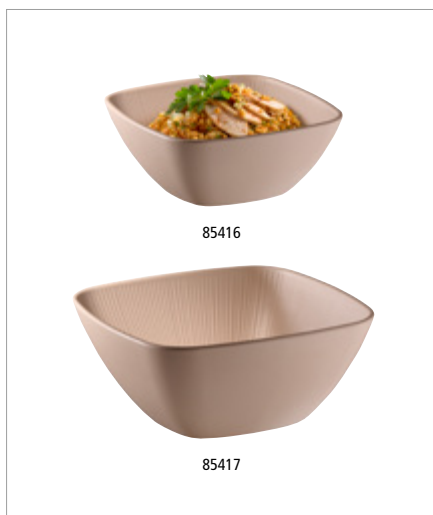

Schale „NERO“

bowl
cuenco
bol



85416

85417

	cm	↑ cm	ltr.	€
85416	19,5 x 19,5	8	1,5	14,20
85417	25,0 x 25,0	11	3,5	23,40

NERO

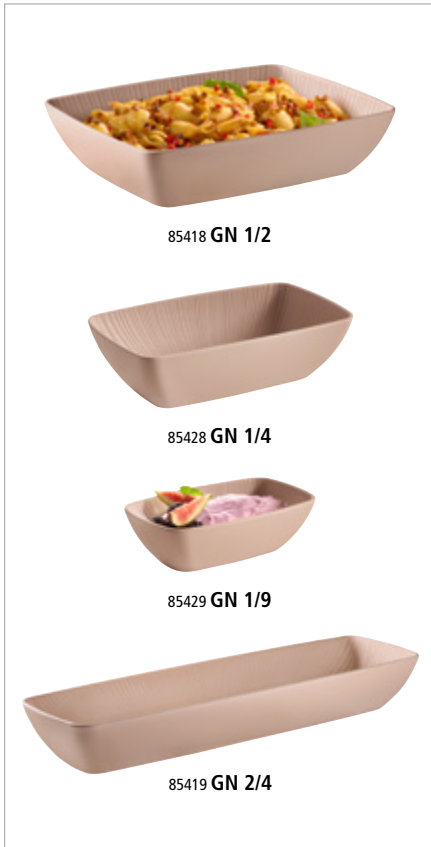

GN Schale „NERO“

GN bowl
GN cuenco
GN bol



	cm	↑ cm	ltr.	GN	€
85418	32,5 x 26,5	7,5	3,50	1/2	24,00
85428 NEW	26,5 x 16,2	7,5	1,50	1/4	18,00
85429 NEW	17,6 x 10,8	5,5	0,35	1/9	8,80
85419	53,0 x 16,2	7,5	3,50	2/4	27,00

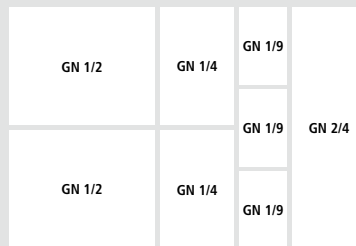

Schale „NERO“

bowl
cuenco
bol



	Ø cm	↑ cm	ltr.	VE / unit	€ / pc.
85430	8	2	0,03	24	2,60



Schale „NERO“

bowl
cuenco
bol



	Ø cm	↑ cm	ltr.	€
85427 NEW	7,0	3,5	0,07	2,80
85407	8,5	3,5	0,1	3,50

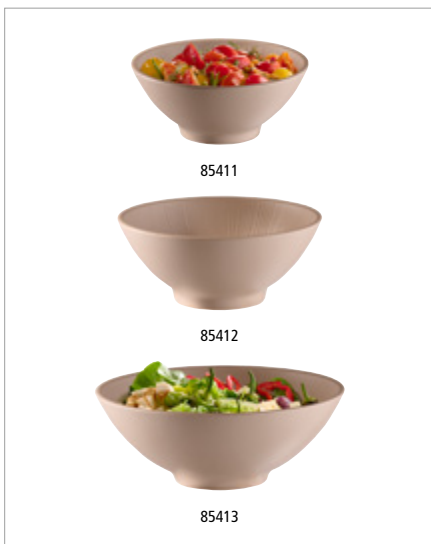

Schale „NERO“

bowl
cuenco
bol



	Ø cm	↑ cm	ltr.	€
85411	16	6,5	0,5	7,20
85412	19	8,0	0,9	10,80
85413	24	9,0	1,7	16,40

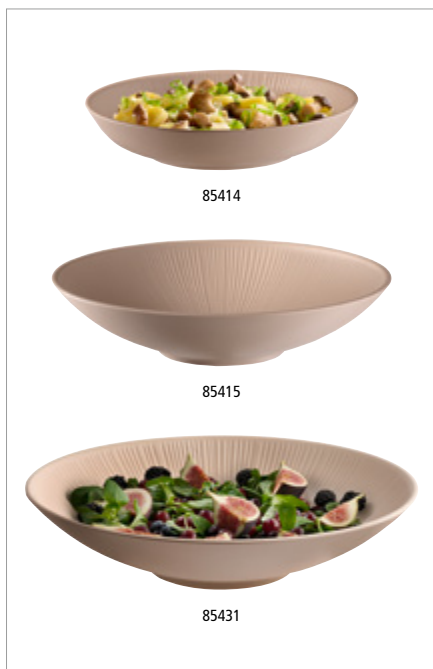

Schale „NERO“

bowl
cuenco
bol



	Ø cm	↑ cm	ltr.	€
85414	22,5	4,5	0,8	11,80
85415	30,0	7,0	2,2	22,00
85431 NEW	35,0	8,0	3,4	24,00

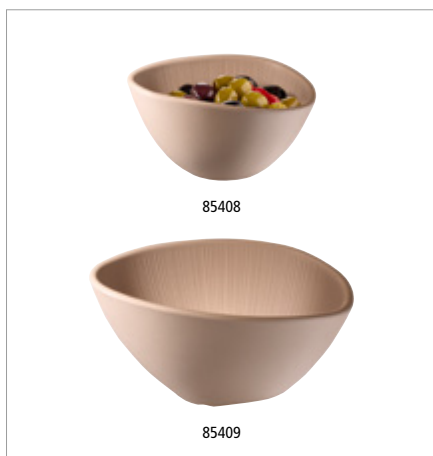

Schale „NERO“

bowl
cuenco
bol



	cm	↑ cm	ltr.	€
85408	14,5 x 12,5	8	0,3	7,00
85409	19,0 x 16,5	9	0,5	9,40



Schale „NERO“

bowl
cuenco
bol



	cm	↑ cm	ltr.	€
85410	23 x 18	5	0,6	12,40



BLUSH



GN Tablett „BLUSH“

GN tray
GN bandeja
GN plateau



	cm	↑ cm	GN	€
85500	53,0 x 32,5	2,5	1/1	44,00
85501	32,5 x 26,5	2,5	1/2	23,00
85512 <small>NEW</small>	32,5 x 17,6	2,5	1/3	18,00
85513 <small>NEW</small>	26,5 x 16,2	2,5	1/4	15,00
85502	53,0 x 16,2	2,5	2/4	23,00

GN 1/1	GN 1/2	GN 1/3	GN 2/4	GN 1/4
	GN 1/2	GN 1/3		GN 1/4
		GN 1/3		

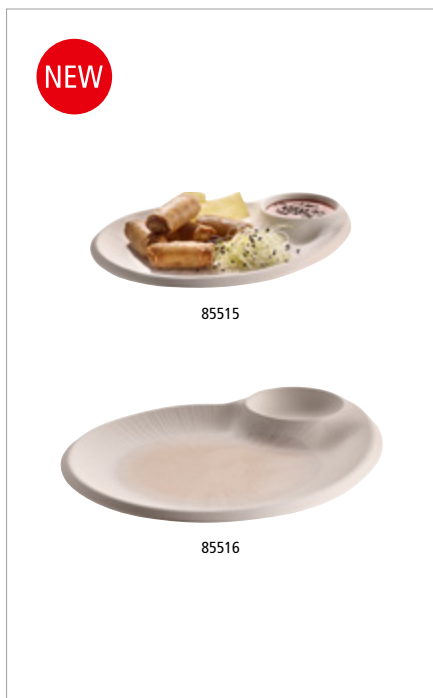

Teller „BLUSH“

plate
plato
assiette

mit integriertem Dipschälchen

with integrated dip bowl
con cuenco para dip integrado
avec ramequin intégré



	cm	↑ cm	ltr.	€
85515	24 x 20	2,5	0,04	10,80
85516	30 x 25	2,5	0,06	14,60

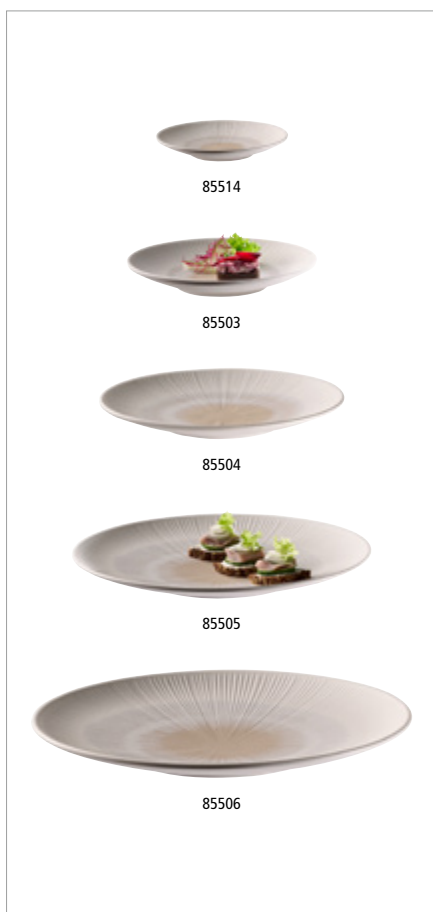

Teller „BLUSH“

plate
plato
assiette



	Ø cm	↑ cm	€
85514 ^{new}	15	3,0	7,00
85503	21	3,0	9,90
85504	26	3,0	11,00
85505	33	3,5	17,00
85506	42	3,5	29,40



Teller „BLUSH“

plate
plato
assiette



	Ø cm	↑ cm	ltr.	€
85507	29	6	0,3	18,90

BLUSH



Schale „BLUSH“

bowl
cuenco
bol



EACH
PIECE
UNIQUE

MAX
70°C



	∅ cm	↑ cm	ltr.	VE / unit	€/ pc.
85523	8	2	0,03	24	2,60



Schale „BLUSH“

bowl
cuenco
bol



EACH
PIECE
UNIQUE

MAX
70°C



	∅ cm	↑ cm	ltr.	€
85521	7,0	3,5	0,07	3,20
85522	8,5	3,5	0,10	3,80

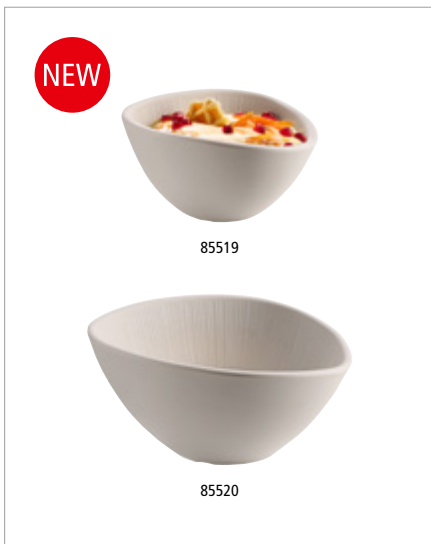

Schale „BLUSH“

bowl
cuenco
bol



EACH
PIECE
UNIQUE

MAX
70°C



	cm	↑ cm	ltr.	€
85519	14,5 x 12,5	8	0,3	8,80
85520	19,0 x 16,5	9	0,5	12,00



Schale „BLUSH“

bowl
cuenco
bol



EACH
PIECE
UNIQUE

MAX
70°C



	cm	↑ cm	ltr.	€
85518	23 x 18	5	0,6	14,20

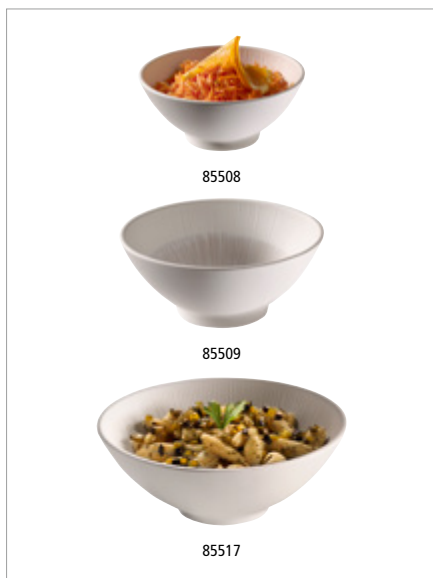

Schale „BLUSH“

bowl
cuenco
bol



	Ø cm	↑ cm	ltr.	€
85508	16	6,5	0,5	8,80
85509	19	8,0	0,9	13,00
85517 NEW	24	9,0	1,7	18,60

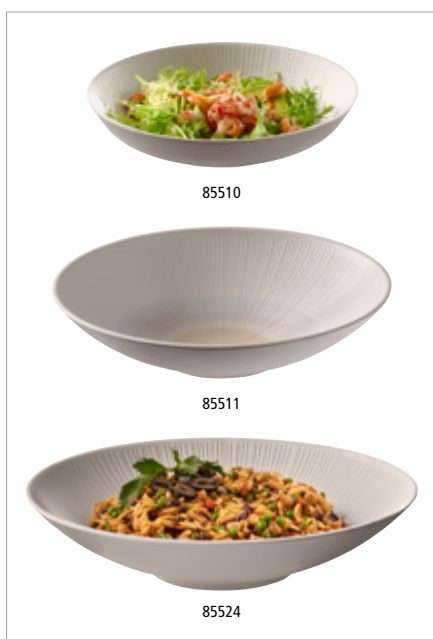

Schale „BLUSH“

bowl
cuenco
bol



	Ø cm	↑ cm	ltr.	€
85510	22,5	4,5	0,8	13,20
85511	30,0	7,0	2,2	24,00
85524 NEW	35,0	8,0	3,4	31,00

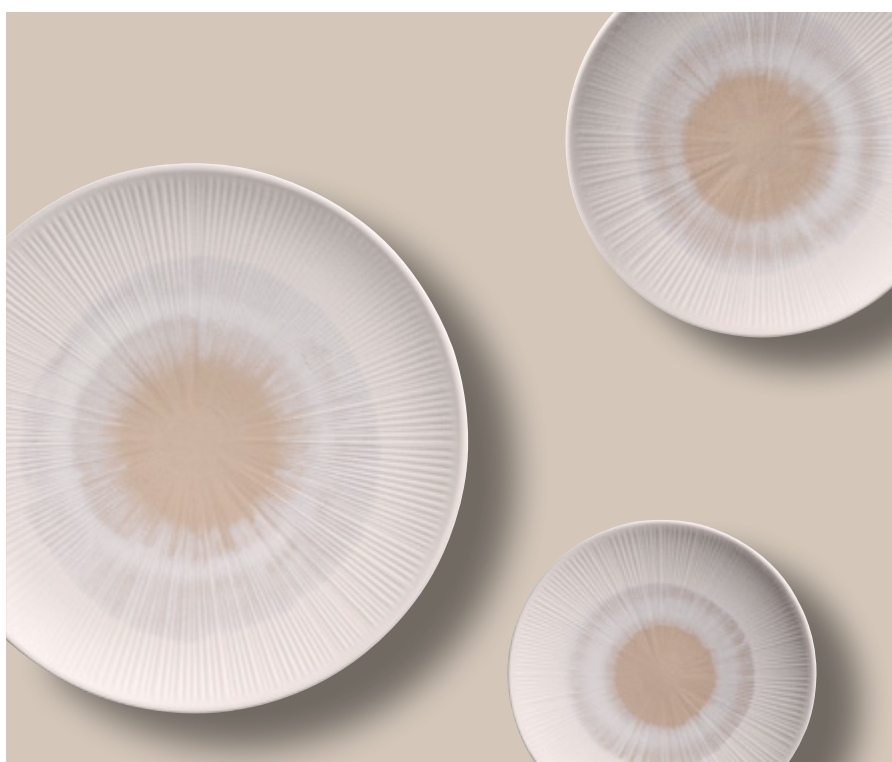

jeder Artikel ist ein Unikat
each item is unique

NERO



GN Tablett „NERO“

GN tray
GN bandeja
GN plateau



	cm	↑ cm	GN	€
85067	53,0 x 32,5	2,5	1/1	39,00
85068	32,5 x 26,5	2,5	1/2	21,00
85280	32,5 x 17,6	2,5	1/3	16,00
85281	26,5 x 16,2	2,5	1/4	13,00
85275	53,0 x 16,2	2,5	2/4	21,00

GN 1/1	GN 1/2	GN 1/3	GN 2/4	GN 1/4
	GN 1/2	GN 1/3		GN 1/4



Tablett „NERO“

tray
bandeja
plateau

mit 2 integrierten Dipschälchen / with 2 integrated dip bowls /
con 2 cuencos para dip integrados / avec 2 ramequins intégrés



	cm	↑ cm	ltr.	€
85097	41 x 15	2,5	2 x 0,03	18,80



Teller „NERO“

plate
plato
assiette

mit integriertem Dipschälchen

with integrated dip bowl
con cuenco para dip integrado
avec ramequin intégré



	cm	↑ cm	ltr.	€
85074	24 x 20	2,5	0,04	9,40
85075	30 x 25	2,5	0,06	12,40



Teller „NERO“

plate
plato
assiette



	Ø cm	↑ cm	€
85073	15	3,0	6,00
85284 <small>NEW</small>	18	3,0	7,00
85063	21	3,0	8,80
85064	26	3,0	9,80
85285 <small>NEW</small>	29	3,0	13,80
85065	33	3,5	15,20
85066	42	3,5	26,00

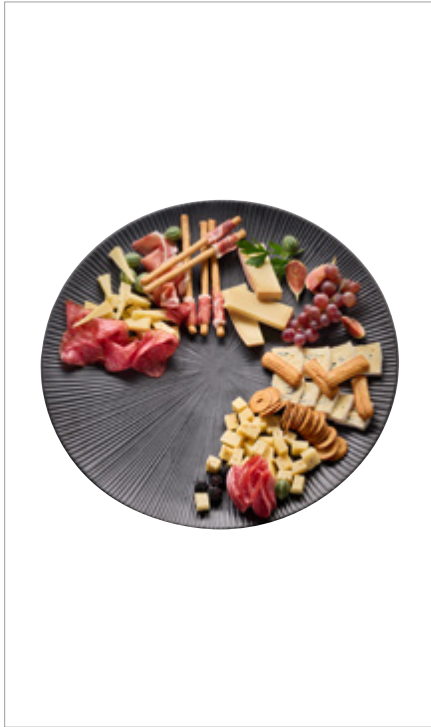

Servierplatte „NERO“

serving plate
plato de servir
plateau de service



	Ø cm	↑ cm		€
85283	50	3,5		44,00



Teller „NERO“

plate
plato
assiette



	Ø cm	↑ cm	litr.		€
85098	29	6	0,3		16,80



Schale „NERO“

bowl
cuenco
bol



	Ø cm	↑ cm	litr.	VE / unit	€ / pc.
85292	8	2	0,03	24	2,30

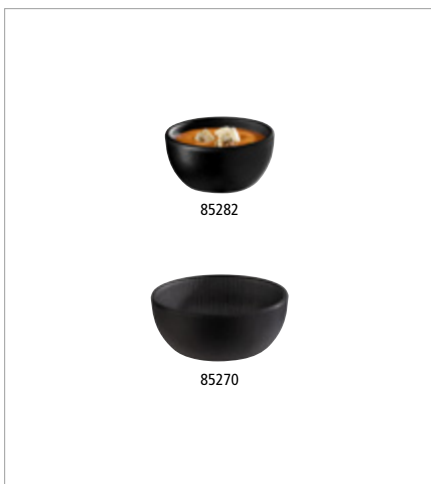

Schale „NERO“

bowl
cuenco
bol



	Ø cm	↑ cm	litr.		€
85282	7,0	3,5	0,07		2,80
85270	8,5	3,5	0,10		3,50



Schale „NERO“

bowl
cuenco
bol



	Ø cm	↑ cm	ltr.	€
85271	12,5	4,5	0,25	7,80
85272	15,5	5,5	0,45	8,80
85273	20,5	7,5	1,20	13,00



Schale „NERO“

bowl
cuenco
bol



	Ø cm	↑ cm	ltr.	€
85286 NEW	10	5,5	0,15	5,80
85287 NEW	13	6,0	0,3	7,00
85069	16	6,5	0,5	7,80
85070	19	8,0	0,9	11,60
85061	24	9,0	1,7	16,40
85288 NEW	29	10,0	2,8	26,00

NERO



85060

85062

85289

Schale „NERO“

bowl
cuenco
bol



	Ø cm	↑ cm	ltr.	€
85060	22,5	4,5	0,8	11,80
85062	30,0	7,0	2,2	22,00
85289 NEW	35,0	8,0	3,4	28,00

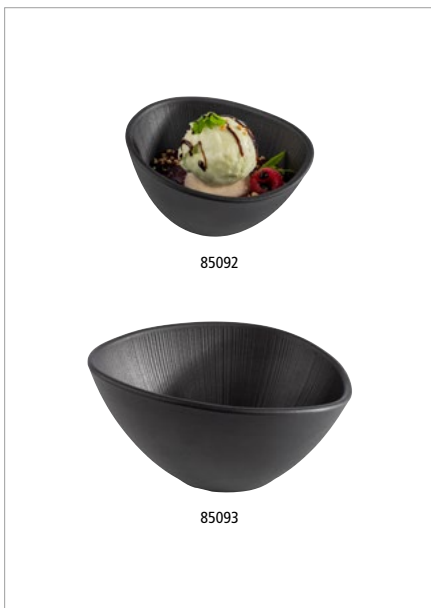

85092

85093

Schale „NERO“

bowl
cuenco
bol



	cm	↑ cm	ltr.	€
85092	14,5 x 12,5	8	0,3	7,60
85093	19,0 x 16,5	9	0,5	10,20



85076

85077

Schale „NERO“

bowl
cuenco
bol



	cm	↑ cm	ltr.	€
85076	23 x 18	5	0,6	12,40
85077	28 x 22	7	0,8	18,80

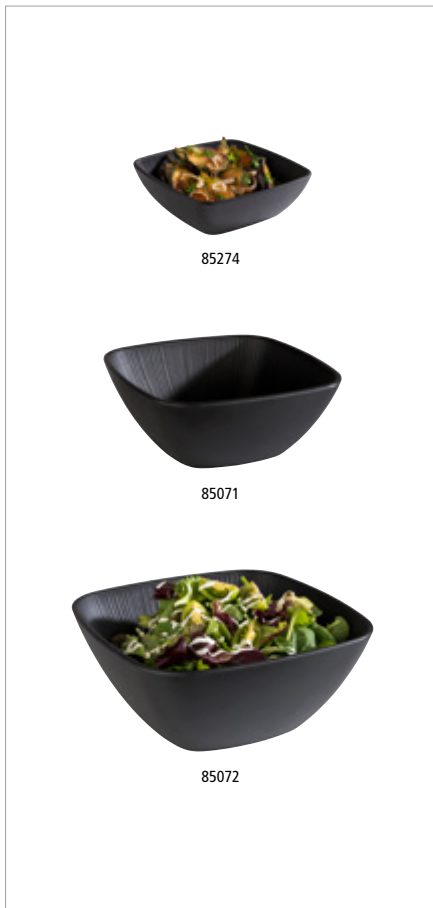

Schale „NERO“

bowl
cuenco
bol



	cm	↑ cm	ltr.	€
85274	16,5 x 16,5	5,5	0,6	9,00
85071	19,5 x 19,5	8,0	1,5	14,20
85072	25,0 x 25,0	11,0	3,5	23,40

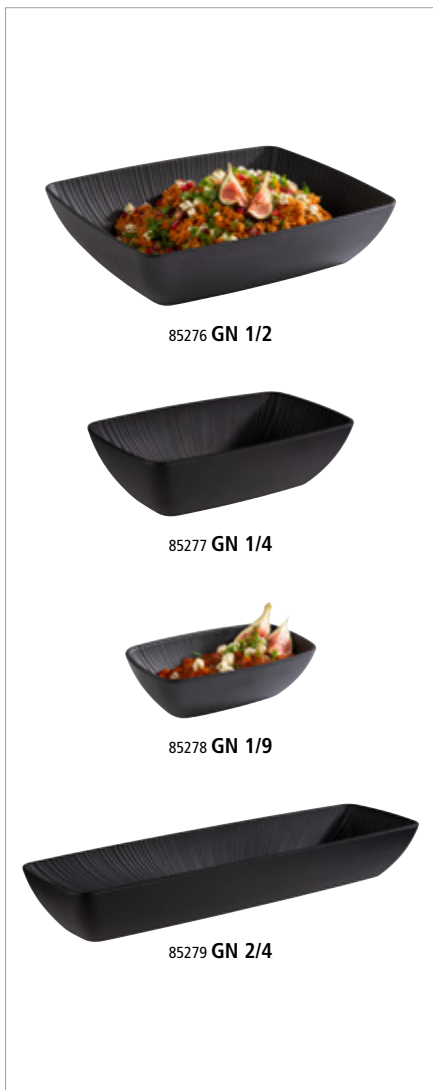

GN Schale „NERO“

GN bowl
GN cuenco
GN bol



	cm	↑ cm	ltr.	GN	€
85276	32,5 x 26,5	7,5	3,50	1/2	24,00
85277	26,5 x 16,2	7,5	1,50	1/4	18,00
85278	17,6 x 10,8	5,5	0,35	1/9	8,80
85279	53,0 x 16,2	7,5	3,50	2/4	27,00

GN 1/2	GN 1/4	GN 1/9	
		GN 1/9	GN 2/4
GN 1/2	GN 1/4	GN 1/9	



CANCUN

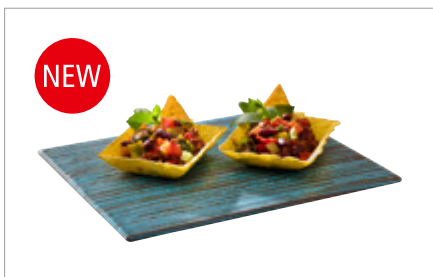

GN Tablett „CANCUN“

GN tray
GN bandeja
GN plateau



	cm	↑ cm	GN	€
85224	32,5 x 26,5	1,5	1/2	25,20



Teller „CANCUN“

plate
plato
assiette



	Ø cm	↑ cm	€
85220	22	2	9,00
85221	27	2	14,50



Teller „CANCUN“

plate
plato
assiette



	Ø cm	↑ cm	€
85202	18	3,0	7,60
85203	23	3,5	15,00



Teller „CANCUN“

plate
plato
assiette



	Ø cm	↑ cm	€
85204	25,5	4,5	15,00

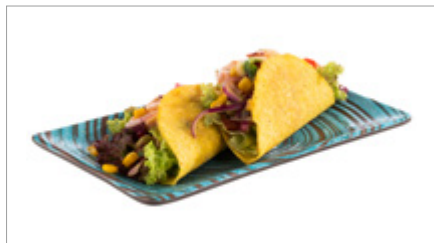

Tablett / Sushiboard „CANCUN“

tray / sushiboard
bandeja para sushi
plateau sushi



	cm	↑ cm	€
85200	23,5 x 13,5	1,5	8,80



Teller „CANCUN“

plate
plato
assiette



	cm	↑ cm	€
85201	28 x 13,5	4	14,00
85223 NEW	34 x 15,5	4	19,60



Schale „CANCUN“

bowl
cuenco
bol



	Ø cm	↑ cm	litr.	€
85205	15,0	7	0,5	8,00
85206	18,5	8	1,0	14,80
85208	24,0	9	1,8	22,00



Schale „CANCUN“

bowl
cuenco
bol



	Ø cm	↑ cm	litr.	€
85207	20,5	6,5	1	16,70
85222 NEW	31,0	8,0	2	36,20

NEW UMI

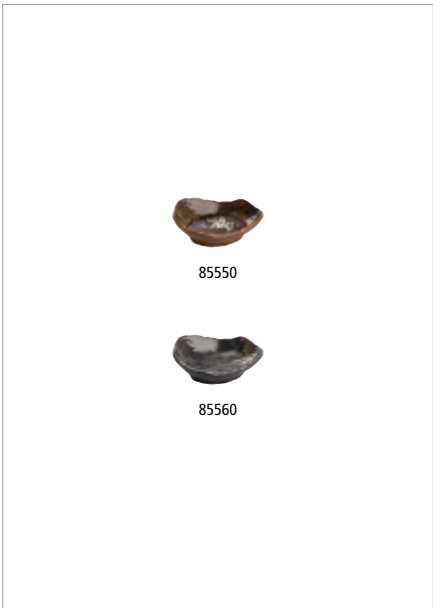

Schale „UMI“

bowl
cuenco
bol



	cm	↑ cm	ml	Farbe / colour	VE / unit	€ / pc.
85550	10 x 8,5	3	50		12	3,40
85560	10 x 8,5	3	50		12	3,40



Tablett / Sushiboard „UMI“

tray / sushiboard
bandeja para sushi
plateau sushi



	cm	↑ cm	Farbe / colour	€
85551	28,5 x 11,5	2		13,80
85561	28,5 x 11,5	2		13,80



Tablett / Sushiboard „UMI“
tray / sushiboard
bandeja para sushi
plateau sushi



	cm	↑ cm	Farbe / colour	€
85552	35 x 10	3		16,00
85562	35 x 10	3		16,00



Tablett / Sushiboard „UMI“
tray / sushiboard
bandeja para sushi
plateau sushi



	cm	↑ cm	Farbe / colour	€
85553	41 x 13	3		21,00
85563	41 x 13	3		21,00



NEW KAYA



Schale „KAYA“
bowl
cuenco
bol



	Ø cm	↑ cm	ml	VE / unit	€/ pc.
85360	8,0	2,5	80	12	3,60



Schale „KAYA“
bowl
cuenco
bol



	Ø cm	↑ cm	ml	VE / unit	€/ pc.
85361	8,5	3,5	100	12	3,60



Schale „KAYA“
bowl
cuenco
bol



	Ø cm	↑ cm	ml	VE / unit	€/ pc.
85362	8,0	4,0 / 5,5	90	12	3,80



Fingerfoodlöffel „DROP“

party spoon
cuchara party
cuillère party



	cm	↑ cm	Farbe / colour	VE / unit	€ / pc.
85370	10,5 x 5,5	3	shiny	12	1,50
85371	10,5 x 5,5	3	shiny	12	1,50



Besteckablage „OVANA“

cutlery tray
reposa cuchara
pose-cuillère



	cm	↑ cm	Farbe / colour	€
85380	16 x 12	2	matt	7,00



Universalzange

all-purpose tongs
pinza universal
pince universelle



	cm	→ cm	Farbe / colour	€
75825	7 x 5	22,5	vintage-look	10,90
75830	7 x 5	25,0	mirror polished	10,80
75831	7 x 5	25,0	gold-look (PVD)	13,10
75832	7 x 5	25,0	copper-look (PVD)	13,10



Salat- / Servierlöffel „BANQUET“

salad spoon / serving spoon
cuchara para ensalada / cuchara de servicio
cuillère à salade / cuillère de service



	cm	Griff / handle cm	€
00588	6,0 x 5,0	17	5,60
00590	7,5 x 6,0	21	8,00

EGGY



Eierbecher Farbmix, 4er Set „EGGY“

egg holder colour mix, 4 pcs. set
huevera mezcla de colores, set de 4
coquetier mélange de couleurs, set de 4



	Ø cm	↑ cm	pcs.	Farbe / colour	€/ set
85298	8,5	2	4	colour mix matt	9,00



Eierbecher, 4er Set „EGGY“

egg holder, 4 pcs. set
huevera, set de 4
coquetier, set de 4



	Ø cm	↑ cm	pcs.	Farbe / colour	€/ set
85297 <small>NEW</small>	8,5	2	4	yellow matt	9,00
85295	8,5	2	4	green matt	9,00
85296	8,5	2	4	grey matt	9,00
83849	8,5	2	4	black matt	9,00
83848	8,5	2	4	white shiny	9,00



Dose, 2er Set „TERRAZZO“

container, 2 pcs.
recipiente, set de 2
boîte, set de 2



ideal zum Servieren von Aufstrichen, Butter, Gewürzen oder kleinen Delikatessen
ideal for serving spreads, butter, spices, or small delicacies
ideal para servir untables, mantequilla, especias o pequeñas delicias
idéal pour servir des tartinades, du beurre, des épices ou de petites gourmandises

	Ø cm	↑ cm	ml	Farbe / colour	€
15917	6	5	40	terrazzo	15,00



Dose, 2er Set „MINERA“

container, 2 pcs.
recipiente, set de 2
boîte, set de 2



ideal zum Servieren von Aufstrichen, Butter, Gewürzen oder kleinen Delikatessen
ideal for serving spreads, butter, spices, or small delicacies
ideal para servir untables, mantequilla, especias o pequeñas delicias
idéal pour servir des tartinades, du beurre, des épices ou de petites gourmandises

	Ø cm	↑ cm	ml	Farbe / colour	€
15918	6	5	40	travertin look	15,00



Dose, 2er Set „MINERA“

container, 2 pcs.
recipiente, set de 2
boîte, set de 2



ideal zum Servieren von Aufstrichen, Butter, Gewürzen oder kleinen Delikatessen
ideal for serving spreads, butter, spices, or small delicacies
ideal para servir untables, mantequilla, especias o pequeñas delicias
idéal pour servir des tartinades, du beurre, des épices ou de petites gourmandises

	Ø cm	↑ cm	ml	Farbe / colour	€
15919	6	5	40	marble green	19,00



Dose, 2er Set „MINERA“

container, 2 pcs.
recipiente, set de 2
boîte, set de 2



ideal zum Servieren von Aufstrichen, Butter, Gewürzen oder kleinen Delikatessen
ideal for serving spreads, butter, spices, or small delicacies
ideal para servir untables, mantequilla, especias o pequeñas delicias
idéal pour servir des tartinades, du beurre, des épices ou de petites gourmandises

	Ø cm	↑ cm	ml	Farbe / colour	€
15920	6	5	40	marble black	19,00



NEW EVERLINE



Trinkflasche „EVERLINE“

drinking bottle
botella para beber
gourde



facettiertes Liniendesign, Trinkflasche aus Glas, Deckel aus Edelstahl
faceted line design, glass drinking bottle, stainless steel lid
diseño de líneas facetadas, botella de vidrio, tapa de acero inoxidable
design de ligne à facettes, gourde en verre, couvercle en acier inox

	Ø cm	↑ cm	ltr.	€
66950	6,5	19,5	0,4	5,60
66951	6,5	23,0	0,5	6,10
66952	7,0	26,0	0,7	6,60



mit Schraubverschluss
with screw cap



EVERFILL



Trinkflasche „EVERFILL“

drinking bottle
botella para beber
gourde

Trinkflasche aus Glas, Deckel aus Edelstahl
glass drinking bottle, stainless steel lid
botella de vidrio, tapa de acero inoxidable
gourde en verre, couvercle en acier inox



	Ø cm	↑ cm	ltr.	€
66935 <small>NEW</small>	6,5	15,0	0,30	4,40
66936 <small>NEW</small>	6,5	18,0	0,40	4,80
66907	6,5	23,5	0,55	5,00
66908	7,0	26,5	0,75	6,10
66909	7,5	28,5	1,00	7,20



mit Schraubverschluss
with screw cap



TO GO



Mehrwegbecher „TO GO“

reusable cup
vaso reutilizable
tasse réutilisable



Becher (ohne Deckel), Rillendesign isoliert die Hitze ohne die Handflächen zu verbrennen
cup (without cover), grooved design insulates the heat without burning your hands
vaso (sin tapa), el diseño acanalado aísla el calor sin quemarte las manos
tasse (sans couvercle), le design rainuré isole la chaleur sans brûler les mains

	Ø cm	↑ cm	ml	Farbe / colour	€
66930 <small>NEW</small>	8,5	11,0	300		2,00
66931 <small>NEW</small>	8,5	11,0	300		2,00
66932 <small>NEW</small>	8,5	11,0	300		2,00
66911	8,5	13,5	400		2,20
66912	8,5	13,5	400		2,20
66913	8,5	13,5	400		2,20



Deckel / cover / tapa / couvercle

	Ø cm	↑ cm	Farbe / colour	€
66915	8,5	2,5		1,10
66916	8,5	2,5		1,10
66917	8,5	2,5		1,10

BRANDING

Gerne bieten wir eine individuelle Gestaltung an.

We are happy to offer an individual design.



1 Deckel | cover

Ø 8,5 cm | H 2,5 cm

1,10 € / Stück (brutto) | pcs. (gross)

2 Becher, ohne Druck | cup, without print

Ø 8,5 cm | H 11,0 cm

2,00 € / Stück (brutto) | pcs. (gross)

Ø 8,5 cm | H 13,5 cm

2,20 € / Stück (brutto) | pcs. (gross)

sofort verfügbar | immediately available



3 1-farbiger Druck | 1-colour print

1,15 € / Stück (netto) | pcs. (net) | (MOQ 500)

1,00 € / Stück (netto) | pcs. (net) | (MOQ 1.000)

4 2-farbiger Druck | 2-colour print

1,35 € / Stück (netto) | pcs. (net) | (MOQ 500)

1,15 € / Stück (netto) | pcs. (net) | (MOQ 1.000)

5 4-farbiger Druck | 4-colour print

2,20 € / Stück (netto) | pcs. (net) | (MOQ 500)

2,00 € / Stück (netto) | pcs. (net) | (MOQ 1.000)

6 Relief / Prägung | relief / embossing

0,45 € / Stück (netto) | pcs. (net) | (MOQ 1.000)

3-4 Wochen | 3-4 weeks delivery time

8 Wochen | 8 weeks delivery time

Druckvorlagen sollten als Vektorgrafik angeliefert werden. Der Druck wird anschließend eingebrannt, sodass der Becher weiterhin spülmaschinengeeignet ist.

Artwork should be supplied as a vector graphic. The print is then burned in so that the cup is still dishwasher-safe.

- ✓ aufsteckbarer Deckel mit Trinköffnung
clip-on lid with drinking opening
- ✓ 100 % recyclebar
100 % recyclable
- ✓ spülmaschinengeeignet
dishwasher safe
- ✓ stapelbar mit und ohne Deckel
stackable with and without lid
- ✓ schwappsicher
slosh-/leak-proof



TABLE ACCESSORIES



Besteckbehälter „TRAVERTINE“

cutlery bin
recipiente para cubiertos
réipients pour couverts

Travertine (Kalkstein), mit Abflussloch, Bodeneinlage aus Silikon zum Schonen des Bestecks

travertine (limestone), with drain hole, silicone bottom insert for protecting the points of knives

travertino (caliza), con orificio de drenaje, soporte de silicona para proteger las puntas de los cuchillos

travertin (calcaire), avec le trou de drainage, insert de silicone pour protéger les pointes des couteaux



	Ø cm	↑ cm	€
11756	11	13,5	29,00

Farb- und Strukturabweichungen möglich
colour and texture variations possible



Zuckerdose, 3-tlg. Set

sugar bowl, 3 pcs.
azucarero, set de 3
sucrier, set de 3

3-teiliges Set, bestehend aus: 1 Zuckerdose, 1 Deckel, 1 Löffel

3 pcs., consisting of: 1 sugar bowl, 1 lid, 1 spoon

set de 3, compuesto por: 1 azucarero, 1 tapa, 1 cuchara

set de 3, composé de: 1 sucrier, 1 couvercle, 1 cuillère



	Ø cm	↑ cm	ml	€
00633	8	6,5	200	13,00

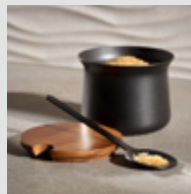

Windaschenbecher „TERRAZZO“

ashtray
cenicero
cendrier

windgeschütztes Design, Asche bleibt sicher im Becher

windproof design, ash remains safely in the cup

diseño protegido contra el viento, las cenizas permanecen seguras en el recipiente

conception protégée du vent, les cendres restent bien dans le récipient



	Ø cm	↑ cm	Farbe / colour	€
00557	10,5	5	 terrazzo	9,80



Farb- und Strukturabweichungen möglich
colour and texture variations possible



Gläserchiene

glass rack
rack de copas
rack porte-verres



inklusive Befestigungsmaterial, Wand- und Deckenmontage möglich

includes mounting hardware, can be mounted under a shelf or on the wall
incluye material de fijación, puede instalarse bajo una estantería o en la pared
matériel de fixation inclus, à installer sous une étagère ou contre un mur

	cm	↑ cm	Farbe / colour		€
93401 <small>NEW</small>	45 x 32	6		black matt	34,00
93400	45 x 32	6		chrome	34,00

Gläser nicht im Lieferumfang enthalten
glasses not included in delivery



Gläserchiene

glass rack
rack de copas
rack porte-verres



inklusive Befestigungsmaterial, Wand- und Deckenmontage möglich

includes mounting hardware, can be mounted under a shelf or on the wall
incluye material de fijación, puede instalarse bajo una estantería o en la pared
matériel de fixation inclus, à installer sous une étagère ou contre un mur

	cm	↑ cm	Farbe / colour		€
93399	29,5 x 32	6		black matt	25,00
93398	29,5 x 32	6		chrome	25,00

Gläser nicht im Lieferumfang enthalten
glasses not included in delivery

GN CONTAINERS



GN-Behälter

GN-container

GN cubetas

GN bacs



transparent: Skalierung in Liter, robust und formstabil

transparent: liter scale, solid quality

transparente: graduación en litros, alta calidad

transparent: graduation en litres, haute-qualité

	GN	↓ mm	ltr.	cm	€
82104	1/1	65	8,5	53 x 32,5	10,20
82106	1/1	100	13,0	53 x 32,5	11,70
82108	1/1	150	19,5	53 x 32,5	13,30
82110	1/1	200	26,0	53 x 32,5	16,30
	GN	↓ mm	ltr.	cm	€
82112	1/2	65	3,9	32,5 x 26,5	5,50
82114	1/2	100	5,9	32,5 x 26,5	6,30
82116	1/2	150	8,9	32,5 x 26,5	7,80
82117	1/2	200	11,8	32,5 x 26,5	9,00
	GN	↓ mm	ltr.	cm	€
82118	1/3	65	2,4	32,5 x 17,5	4,60
82120	1/3	100	3,6	32,5 x 17,5	5,30
82122	1/3	150	5,3	32,5 x 17,6	6,90
82123	1/3	200	7,0	32,5 x 17,6	7,90



GN-Deckel

GN-lid

GN tapa

GN couvercle



	GN	↑ cm	cm	€
82101	1/1	1,5	53,0 x 32,5	5,70
82113	1/2	1,5	32,5 x 26,5	3,40
82119	1/3	1,5	32,5 x 17,6	2,90

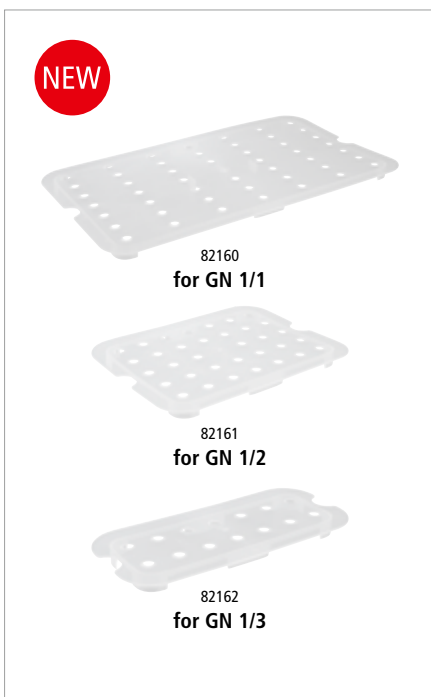

GN Abtropfgitter

GN drainer

GN escurridor

GN égouttoir



feine Lochung für effizientes Abtropfen, Abstandhalter zum Behälterboden verhindern, dass Lebensmittel in Flüssigkeit liegen

Fine perforations for efficient draining, spacers on the container base prevent food from lying in liquid

Perforaciones finas para un drenaje eficaz, los separadores en la base del recipiente evitan que los alimentos queden sumergidos en el líquido

Perforations fines pour un drainage efficace, des entretoises au fond du récipient empêchent les aliments de rester dans le liquide

	cm	↑ cm	for GN	€
82160	47,3 x 26,8	2	1/1	5,00
82161	26,8 x 20,8	2	1/2	3,00
82162	26,8 x 11,8	2	1/3	2,40



MIX
Papier | Fördert
gute Waldnutzung
FSC® C106855



DE Impressum

Herausgeber: Assheuer + Pott GmbH & Co. KG, Talweg 11, 59846 Sundern, Tel. +49 2933 97350, info@aps-germany.de, www.aps-germany.de
Gestaltung: Assheuer + Pott GmbH & Co. KG · Druck: Vormann Druck & Verlag GmbH, Im Braukhausiepen 3, 58802 Balve
Wir behalten uns das Recht vor, die angegebenen Spezifikationen jederzeit zu ändern. Irrtum, Druckfehler und technische Änderungen vorbehalten.
Artikelbeschreibungen sowie Abbildungen und Fotodarstellungen sind ohne Gewähr. Alle Angebote ohne Dekoration.
Alle Preise verstehen sich unverbindlich (UVP) in Euro zuzüglich der gesetzlichen Mehrwertsteuer.
© 2026 – Jede Vervielfältigung dieses Katalogs, auch auszugsweise, bedarf der ausdrücklichen Genehmigung der Assheuer + Pott GmbH & Co. KG.
Bildnachweis: Niklas Thiemann Fotodesign, Stoll GmbH – Studio für Fotografie, ZENITH Werbung & Fotografie GmbH & Co. KG, iStock, Envato Elements Pty Ltd.,
Media Impression GmbH, MPB-Schnücker, track by track GmbH, stock.adobe.com, sieger design GmbH & Co. KG, CASA-Fotoatelier für Werbung GmbH & Co. KG

EN Imprint

Editor: Assheuer + Pott GmbH & Co. KG, Talweg 11, 59846 Sundern, Germany, Tel. +49 2933 97350, info@aps-germany.de, www.aps-germany.de
Design: Assheuer + Pott GmbH & Co. KG · Print: Vormann Druck & Verlag GmbH, Im Braukhausiepen 3, 58802 Balve, Germany
We reserve the right to alter at any time the specifications stated without notice. Errors, printing error and technical changes reserved. Item description as well as images and illustrations are without guaranty. All offers are without decoration.
All prices are without commitment (RRP) in Euro and exclude the legal VAT prescribed by law.
© 2026 – This catalogue may not be reproduced in whole or in part unless specific prior written authorization of Assheuer + Pott GmbH & Co. KG.
Picture credits: Niklas Thiemann Fotodesign, Stoll GmbH – Studio für Fotografie, ZENITH Werbung & Fotografie GmbH & Co. KG, iStock, Envato Elements Pty Ltd.,
Media Impression GmbH, MPB-Schnücker, track by track GmbH, stock.adobe.com, sieger design GmbH & Co. KG, CASA-Fotoatelier für Werbung GmbH & Co. KG



buffet | tabletop | bar

Assheuer + Pott GmbH & Co. KG
Talweg 11, 59846 Sundern / Germany

aps-germany.de



no. 3823



€